



26950 San Bernardino Ave. • Redlands, CA 92374

(909) 379-0123

Toll Free: (866) 629-6636

Fax (909) 379-0169

October 1, 2016

Dear Valued Customer:

Enclosed you will find a new Precision catalog, along with the most up-to-date price book that features new lower pricing on selected doors and components. **(Please contact your Precision sales representative for a copy of your current pricing modifier sheet).**

Additionally, below are just a few of many innovations that have been added to our product offering.

- Oceanside swinging screen door (Page 7 of Section 1)
- Steel security mesh options (Page 19 of Section 2)
- Custom water jet cut patterns for steel doors, gates and fencing (Pages 20-23 of Section 2)

We sincerely believe Precision Screen & Security Products provides the highest quality products and services in Screening Components, Screen Doors, Security Doors, Window Guards, Fencing, Gates and that our new product offerings will exceed customer expectations.

With Highest Regards,

Precision Screen & Security Products

ABOUT US...

PRECISION

For over 50 years, Precision has been known for manufacturing quality window and door products as well as other hardware for the commercial and home consumer market.

Our innovative manufacturing process allows us to offer a wide assortment of product offerings including:

- Steel security doors
- Custom security doors
- Swinging screen doors
- Sliding screen doors
- Custom gates and fencing
- Commercial gates and fencing
- Window guards
- Protective grills
- KD kits
- Custom color options
- Vinyl screen doors

Precision has long been known for its “one-call” service, and we continue to expand our capabilities to provide the most innovative and broadest selection at a great value.

Our customer promise:

- Provide the best customer service in the industry
- Focus on quality and value
- Industry knowledge leader
- Maintain extensive product assortment
- Continue to bring innovation to the market
- Inventory on-hand and ready to ship on stock items
- Nationwide coverage

Precision is part of Prime-Line Products, the industry leader in supplying repair and replacement parts for commercial and home properties in North America. Prime-Line also distributes and offers other brands and product lines, which include:

- Window and door replacement hardware
- Screen products and accessories
- Security hardware
- Child safety
- Plumbing replacement parts
- Toilet partition hardware

Prime-Line is proud to be an ESOP – Employee Owned Company located in Redlands, California with over 400 employees.



TO OUR VALUED CUSTOMERS:

Effective date: _____

Your account#: _____

Your sales representative is: _____

Direct order desk phone: _____

Your delivery days are: _____

Hours of Operation:

8 am – 5 pm, Monday – Friday

Phone: _____

Fax: _____

Mon. Tues. Wed. Thurs. Fri.

TERMS AND CONDITIONS

PRICES & ORDERING

Prices do not include freight, taxes and duties and are subject to change without notice. Typographical errors are subject to correction. Items will be invoiced at prices current at the time of shipment. Minimum order \$25.00.

Any quotes are valid for 30 days from the time of written quotation unless otherwise stated.

All orders are accepted subject to availability of merchandise. Orders must be modified or canceled within one (1) hour of entry or fees may apply. All orders are confirmed via fax or e-mail, and are the customer's responsibility to verify. All orders will be accepted on a ship and cancel basis, unless otherwise requested.

Due to engineering upgrades and manufacturing variance, the actual replacement part may or may not look identical to the representative illustration.

Need It But, Don't See It? We welcome the opportunity to source and locate parts not shown in the catalog. Send an electronic image to Customer Service at Customerservice-ppsp@precisionplp.com Or mail your sample. Sample items can be shipped freight prepaid with tracking number to Precision Screen & Security Products, Attn: Director of Customer Service, 26950 San Bernardino Avenue, Redlands, CA 92374. Please include a brief note with your name, address and phone number indicating this is a sample for identification purposes. Samples will be returned within two (2) weeks.

Special orders are non-cancelable, non-returnable and must be ordered via a purchase order from the Purchaser. All special orders will be shipped in accordance with quoted lead times. Minimum order quantities may be required on special orders or bulk orders. Bulk orders may be shipped at industry standard $\pm 10\%$ of the order quantity. Purchaser is liable for the entire order quantity. Special discounting is available on large quantity orders; call (866) 629-6636 for pricing and availability.

CUSTOM ORDERS

A signed confirmation must be received by Precision Screen & Security Products before any custom orders are scheduled for production. Precision is not responsible for any errors and/or omissions in customer verified information.

COD Custom Orders: All COD custom orders must have a 50% non-refundable deposit towards the total invoice value before production takes place.

TERMS

Precision Screen & Security Products accepts Visa, MasterCard, American Express, Discover, Diner's Card and Cash On Delivery (COD). For customers with established Precision Screen & Security Products credit, payment terms are net thirty (30) days from the date of shipment or pick-up of products. Credit application must be completed in full. All credit extended by Precision Screen & Security Products and the limits of such credit, is at Precision Screen & Security Products' sole discretion, and may be reduced or revoked by Precision Screen & Security Products at any time, for any reason. Precision Screen & Security Products reserves the right to charge customer a late payment fee at the rate of one and one-half percent (1.5%) of the amount due for each month or portion thereof that the amount due remains unpaid, or such amount as may be permitted under applicable law.

Precision Screen & Security Products has the right, at any time and in its sole discretion, to immediately change the terms of any credit extended to customer if: (i) there is a material change in customer's financial capability or creditworthiness; (ii) customer enters into or

signs an agreement regarding any Change of Control; or (iii) a trustee, receiver or examiner is appointed for customer or its affiliates or subsidiaries or customer's plan of reorganization is confirmed by a U.S. Bankruptcy Court.

Additionally, customer, and each of its subsidiaries and affiliates, agrees to provide to Precision Screen & Security Products proper authorization necessary for Precision Screen & Security Products to request any financial information from third parties.

FREIGHT

Prices stated are F.O.B. origin, freight prepaid to destination specified in the order.

Precision Screen & Security Products covers shipping and handling for standard ground delivery for orders within a 100-mile radius and over US \$225 before tax and freight (including any backorders). Please call to obtain current delivery schedules and delivery minimums for other delivery points. All shipments outside of PSSP delivery areas will be shipped via "common carrier" collect at customer's expense. "Job Site" or "Drop Shipment" deliveries are available in some areas on normal scheduled delivery days. A "Job Site" or "Drop Shipment" fee will apply. All COD job site deliveries shall be paid prior to the delivery.

Where Precision Screen & Security Products is the carrier, claims for damaged material, shortages or errors must be reported within five (5) working days after receipt of shipment. All claims reported after the five working day grace period will be subject to Precision authorization. All claims must be processed within thirty (30) calendar days.

Other terms and conditions may apply for other than standard ground delivery.

Accessorial Charges, including but not limited to over size and residential delivery charges, will be passed through from the carrier and must be paid by customer. Fuel surcharges may be applied.

Title and all risk of damage or loss pass to customer upon tender of shipment to the carrier. Our obligation to effect shipment of products will be fully discharged upon delivery to the carrier. If the product is damaged in transit, customer's only recourse is to file a claim with the carrier.

Precision will not be responsible for any failure to perform due to causes beyond its reasonable control (each, a "Force Majeure") including, but not limited to, acts of God, war, riot, embargoes, acts of civil or military authorities, denial of or delays in processing of export license applications, fire, floods, earthquakes, accidents, strikes, or fuel crises, provided that Precision gives prompt written notice thereof. The time for performance will be extended for a period equal to the duration of the Force Majeure, but in no event longer than sixty (60) days.

RETURNS

Items must be returned within 30-days from date of purchase. No returns will be accepted without pre-authorization from Precision Screen & Security Products. Contact Customer Service at (866) 629-6636 for a return authorization number. A freight and re-stocking charge (15%) may be applied. Obsolete or discontinued items may not be accepted. NON-STOCKED, CUSTOM OR SPECIAL ORDER PRODUCTS CANNOT BE RETURNED. All items that arrive with damaged packaging will be subject to a \$20.00 re-packaging fee. DAMAGED PRODUCTS ARE NOT RETURNABLE, NO EXCEPTIONS.

ACCEPTANCE

Placement of an order constitutes acceptance of these terms and conditions.

LIMITED WARRANTY

Except as provided below, Precision Screen & Security Products warrants this product solely against defects in material and workmanship for 1 year from the date of purchase and will refund the purchase price or offer product replacement only. Claimant must provide copy of purchase receipt and supply at claimant's expense product for inspection at Precision's normal place of business unless otherwise agreed. Precision expressly disclaims any, and makes no, representation about the suitability of this product for any purpose, and, except for the limited warranty expressly set forth above, or to the extent restricted or prohibited by law, makes no warranties, either express or implied, including quality, merchantability and fitness for a particular purpose. Precision agrees only to replace the product or to refund the purchase price, at its sole discretion, in the event a claim is accepted, and in no event will Precision be liable for an amount in excess of the payments received by Precision, or for any direct, indirect, incidental, special, punitive, consequential, or exemplary damages (including but not limited to lost profits, revenue, data, lost goodwill, cost of procurement of substitute equipment or property incurred by you or any third party, arising from product failure.) Any tampering, negligence or use in a manner other than intended invalidates this warranty.

- **PRODUCTS INSTALLED WITHIN 5 MILES OF ANY COASTAL REGION, OR SUBJECTED TO EXCESSIVE AND/OR CONSISTENT, MOISTURE CANNOT BE WARRANTED AGAINST RUST OR CORROSION.**
- **OPPORTUNITY TO REVIEW THE PRODUCT'S ORIGINAL CONDITION. INSPECTION OF YOUR PRODUCT UPON POSSESSION OR DELIVERY IS YOUR ONLY.**

Damage resulting from installation or transportation is not Precision's responsibility. Installation and/or transportation of this product releases Precision from any liability for surface scratches, dents, warping, jamb misalignment, frame gaps, or any other structural problems of such nature that can be caused during the installation and/or transportation, and are not the responsibility of Precision. Contact your installer or transporter directly, if applicable, for resolution. Products such as steel security doors can make noise from component rattling when closed. This is not a warranty issue. Chemicals may react to paint finishes and cause discoloration. This is not under warranty. This warranty expressly excludes the screen mesh and mesh components, which include rips, tears, separation, fraying, snags in or on screen material, or the detaching of the screen material from the spline channel. Specific warranty periods may vary based on door model and color configuration (see below); please refer to the information provided on your door model or inquire for further details.

Warranty Period Product Guide

Black, White, Bronze, Almond, Adobe, Weathered Brown 1 Year from the purchase date
Economy Doors 90 Days from the purchase date

If you have a warranty claim please notify Precision Screen and Security Doors and have the following information available:

Door Model Number: _____

Dated Proof of Purchase Receipt _____

Name of Installer (if installed by other than homeowner) _____

Detailed explanation of the defect (photos may be requested by Precision) _____

We're Serious About QUALITY



QUALITY CHECKLIST

- 1 **Custom Options:** Reference sales order / work order (248541, 484625)
- 2 **Door Specifications:**
Finished door outer dimension: Height 78 in. Width 48 3/4 in. Lock box height _____ in.
- Hinged side
Single door: Left _____ Right _____ Double door (active): Left _____ Right _____
- Door frame:
3 sided _____ 4 sided _____
- 3 **Quality:**
Scratches _____ Thin paint _____
- 4 **Style:**
Door style: Essex Door color: WHT Perf color: Charcoal F
- Inspected by: CR Date: 5-20-16

LIT595

Precision Screen & Security Products
supplies a quality inspection sticker
on every door we make.

PRECISION “SAFEGUARD” PACKAGING

We take special measures to assure your products are protected during delivery to your business and packaged to stand up to the loading and reloading that is common to our industry. We know as you prepare for delivery to your customer, that you need the product to be as protected as possible. We take pride in being unique to the industry in this regard.

❖ Hardware pack securely packaged.



❖ Completely shrink-wrapped for protection.

❖ Protected Corners



COLOR SELECTIONS

Precision Deluxe Powder Coat

Semi-Gloss Finish



Black



White

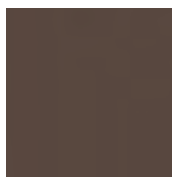

Bronze



Almond



Adobe

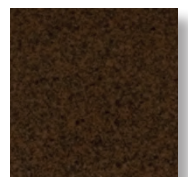

Weathered
Brown

Note: The colors shown are only representations of color selections. Please refer to Color Key Samples in order to guarantee exact match.

- Not all selections available in every door style. See individual door pages.

CO-OP ADVERTISING OPPORTUNITIES

Let's Work Together to Grow Our Businesses!



Door Hangers



Home Center Shows

Direct Mail

Contact you sales representative today!



DID YOU — KNOW —

Precision makes custom steel products for commercial and residential use

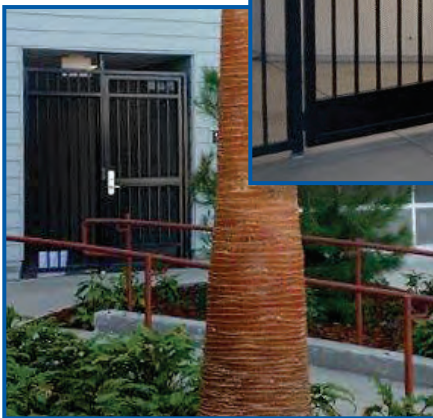
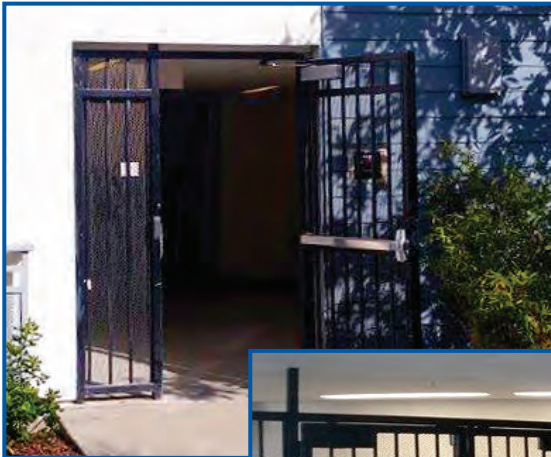

- Security gates
- Fencing
- Garage entry barriers
- Rolling gates up to 30 ft. long
- Perimeter controlled access (to fit any opening)
- Frame sizes up to 2 in. x 6 in. available (6 in. x 6 in. posts)

Let our commercial division bid on your next project. Call our design specialist Clay Walls to discuss your project needs.



1
Swinging Screen



17 Steel Security

63 Sliding Screen



Page

i | ABOUT US

1 | SECTION 1
Swinging Screen Doors

17 | SECTION 2
Domestic Steel Security Doors

Page

55 | SECTION 3
Economy Steel Security Doors

63 | SECTION 4
Sliding Screen Doors

75 | SECTION 5
Wood/Vinyl Screen Doors



75 Wood Screen

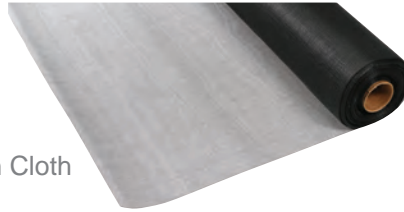

93 Screen Cloth

115 Tools



CONTENTS

Page

79 | SECTION 6
Steel Storm Doors

85 | SECTION 7
Door Grilles & Accessories

89 | SECTION 8
Pet Doors & Accessories

Page

93 | SECTION 9
Screen Cloth, Roll Goods & Spline

99 | SECTION 10
Window Screen Frame &
Components

115 | SECTION 11
Tools & Supplies

SECTION 1 / SWINGING SCREEN DOORS

PRODUCT	PAGE
Extruded aluminum security & deluxe screen doors.....	2-7
Economy roll form screen doors.....	7-8
Door list	9
Custom options	10
Handle hardware - standard & upgrade	11
Double door astragal kits.....	12
Bottom & side adjustment channels	13
Worksheet & sizing chart	14
Order form	15

STEEL & EXTRUDED ALUMINUM SCREEN DOORS

This section includes an example and specifications on Precision’s line of extruded aluminum screen and extruded aluminum security screen doors. These products are manufactured at our Redlands, CA plant.

All Precision aluminum screen and security screen doors have a 1 (one) year warranty on workmanship and material (see terms and conditions page for details.)

The pictures shown illustrate some of the finish options available. Standard finishes are indicated on each page. See our Precision color selections page.

Standard sizes shown are “call-out” sizes. The actual “standard” net frame size is indicated in this chart.

“STANDARD” NET FRAME SIZE

Extruded aluminum security door:

Centurion, Vanguard

Extruded aluminum

Athens 29-1/4", 31-1/4" & 35-1/4" x 79-1/2"

Extruded aluminum swinging door:

Brighton, Clearview, Colonade, Fiesta,

Oceanside, Safeguard, Santa Cruz,

Santa Cruz “Full Grille” 29-1/4", 31-1/4" & 35-1/4" x 79-1/4"

Roll form swinging door:

Provincial, Capri, Promo 31-1/8" & 35-1/8" x 79-3/4"

The “net overall size” is the door without hinge/bottom adjustment channels.

See pages at the end of this section for information regarding the custom order sizes, prices and options available on Precision aluminum doors.

For any questions regarding any Precision products or specifications, please contact your sales representative or call Precision order desk.

Features

- 2-7/8" x 7/8" .062 Extruded aluminum frame
- Standard sizes
2'6" x 6'8" (29-1/4" x 79-1/2")
2'8" x 6'8" (31-1/4" x 79-1/2")
3'0" x 6'8" (35-1/4" x 79-1/2")
- Custom widths 24" up to 41-1/4", heights up to 96"
- Lever handle combination deadbolt lock in antique brass (2961BZ), black (2962BK) or white (2977WH)
- Heavy duty closer included
- **Must specify handing**
- Keyed alike cylinders available
- Charcoal fiberglass insect screening
- 1-1/2" .050 side adjustable channel - 3 hinges
- 1-1/2" .050 bottom adjustment channel
- Extruded amplimesh 1/4" aluminum centurion grille
- Precision SAFEGUARD packaging - complete with hardware

Standard Finishes

- Adobe, almond, bronze or white powder coated
- Bronze or satin anodized
- No special colors available for this door

Options

- Custom size
- Pre-hung kit
- Screen cloth upgrade

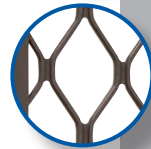

Extruded Aluminum Security Screen Door



3/0 = 36" • 2/8 = 32" • 2/6 = 30"

Features

- 2-7/8" x 7/8" .062 Extruded aluminum frame
- Standard sizes only - No custom sizes
2'6" x 6'8" (29-1/4" x 79-1/2")
2'8" x 6'8" (31-1/4" x 79-1/2")
3'0" x 6'8" (35-1/4" x 79-1/2")
- Lever handle combination deadbolt lock in antique brass (2961BZ), black (2962BK) or white (2977WH)
- Heavy duty closer included
- **Must specify handing**
- Keyed alike cylinders available
- Extruded amplimesh grille
- Charcoal fiberglass insect screening
- 1-1/2" .050 side adjustable channel - 3 hinges
- 1-1/2" .050 bottom adjustment channel
- Precision SAFEGUARD packaging - complete with hardware

Standard Finishes

- Bronze or white powder coated
- No special colors available for this door

Options

- No options available

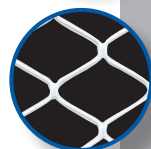

Extruded Aluminum Security Screen Door



3/0 = 36" • 2/8 = 32" • 2/6 = 30"

Extruded Aluminum
"Heavy Duty" Screen Door



3/0 = 36"

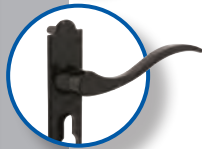

Features

- 2-7/8" x 7/8" .062 Extruded aluminum frame
- Standard size only - No custom sizes
3'0" x 6'8" (35-1/4" x 79-1/2")
- Lever handle combination deadbolt lock in black (2962BK) or white (2977WH)
- Heavy duty closer included
- Heavy duty steel architectural arched insert
- Charcoal fiberglass insect screening

• Must specify handing

- Keyed alike cylinders available
- 1-1/2" .050 side adjustable channel - 3 hinges
- 1-1/2" .050 bottom adjustment channel
- Precision SAFEGUARD packaging - complete with hardware

Standard Finishes

- Almond, bronze or white powder coated

Options

- No options available

BRIGHTON (Series 3525)

Extruded Aluminum
Screen Door



3/0 = 36" • 2/8 = 32" • 2/6 = 30"



Features

- 2-1/8" x 3/4" .050 Extruded aluminum frame
- Standard sizes
2'6" x 6'8" (29-1/4" x 79-1/4")
2'8" x 6'8" (31-1/4" x 79-1/4")
3'0" x 6'8" (35-1/4" x 79-1/4")
- Custom widths 24" up to 47-7/8", heights up to 110"
Extra charges will apply for doors over 96" in height
- 1" wide sculptured 9 lite marginal grid pattern
- Charcoal fiberglass insect screening
- Standard push button handle
- 1-7/8" .050 side adjustable channel - 3 hinges
- 1-7/8" .050 bottom adjustment channel
- Precision SAFEGUARD packaging - complete with hardware

Standard Finishes

- Adobe, almond, black, bronze or white powder coated

Options

- Custom size
- 9" Kick plate
- Pre-hung kit
- Screen cloth upgrade

Features

- 2-1/8" x 3/4" .050 Extruded aluminum frame
- Standard 6" embossed .024 aluminum kickplate (8-1/8" overall)
- Standard sizes
2'6" x 6'8" (29-1/4" x 79-1/4")
2'8" x 6'8" (31-1/4" x 79-1/4")
3'0" x 6'8" (35-1/4" x 79-1/4")
- Custom widths 29" up to 47-7/8", heights up to 110"
Extra charges will apply for doors over 96" in height
- Charcoal fiberglass insect screening
- Standard push button handle

Series 4510 KD kit available (no kickplate)

- 1-7/8" .050 channel side adjustable - 3 hinges
- 1-7/8" .050 bottom adjustment channel
- Precision SAFEGUARD packaging - complete with hardware

Standard Finishes

- Adobe, almond, black, bronze or white powder coated
- Bronze or satin anodized

Options

- Custom size
- Handle upgrade
- Kick plate
- Pet door
- Pre-hung kit
- Push bar
- Screen cloth upgrade

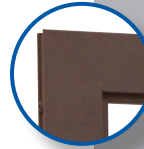

Extruded Aluminum Screen Door



3/0 = 36" • 2/8 = 32" • 2/6 = 30"

Features

- 2-1/8" x 3/4" .050 Extruded aluminum frame
- Standard sizes
2'6" x 6'8" (29-1/4" x 79-1/4")
2'8" x 6'8" (31-1/4" x 79-1/4")
3'0" x 6'8" (35-1/4" x 79-1/4")
- Custom widths 29" up to 47-7/8", heights up to 120"
Extra charges will apply for doors over 96" in height
- 1" wide sculptured 15 lite grid pattern
- Charcoal fiberglass insect screening
- Standard push button handle
- 1-7/8" .050 side adjustable channel - 3 hinges
- 1-7/8" .050 bottom adjustment channel
- Precision SAFEGUARD packaging - complete with hardware

Standard Finishes

- Adobe, almond, black, bronze or white powder coated

Options

- Custom size
- Handle upgrade
- Kick plate
- Pre-hung kit
- Screen cloth upgrade



Extruded Aluminum Screen Door



3/0 = 36" • 2/8 = 32" • 2/6 = 30"

Extruded Aluminum
Screen Door

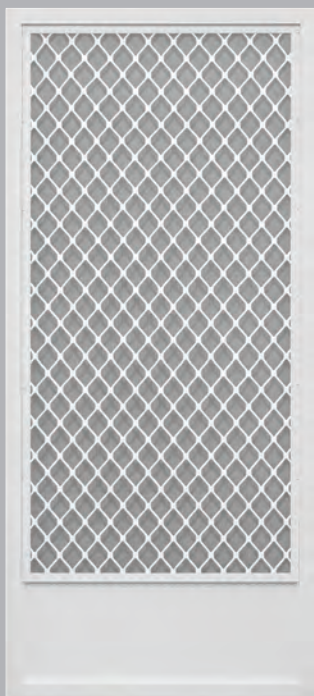

3/0 = 36" • 2/8 = 32" • 2/6 = 30"



Features

- 2-1/8" x 3/4" .050 Extruded aluminum frame
- Standard 12" embossed .024 aluminum kickplate
- Standard sizes
2'6" x 6'8" (29-1/4" x 79-1/4")
2'8" x 6'8" (31-1/4" x 79-1/4")
3'0" x 6'8" (35-1/4" x 79-1/4")
- Custom widths 36" up to 41-1/4", heights up to 81"
Grille turned sideways on doors over 35-1/4" wide
- Charcoal fiberglass insect screening
- Standard push button handle
- 1-7/8" .050 side adjustment channel - 3 hinges
- 1-7/8" .050 bottom adjustment channel
- Extruded amplimesh 3/16" aluminum grille
- Precision SAFEGUARD packaging - complete with hardware

Standard Finishes

- Adobe, almond, bronze or white powder coated
- Satin anodized

Options

- Pet door

SANTA CRUZ (Series 3521)

Extruded Aluminum
Screen Door

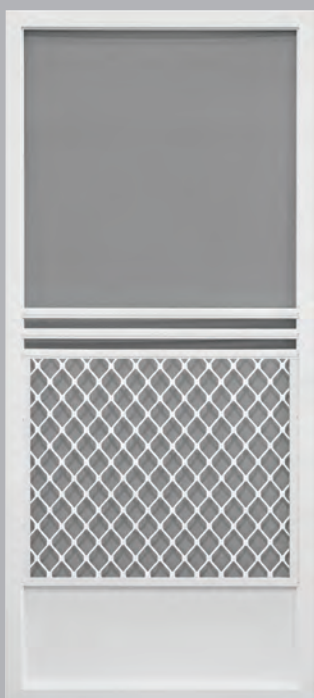

3/0 = 36" • 2/8 = 32" • 2/6 = 30"



Features

- 2-1/8" x 3/4" .050 Extruded aluminum frame
- Standard 12" embossed .024 aluminum kickplate
- Standard sizes
2'6" x 6'8" (29-1/4" x 79-1/4")
2'8" x 6'8" (31-1/4" x 79-1/4")
3'0" x 6'8" (35-1/4" x 79-1/4")
- Custom widths 24" up to 41-1/4", heights up to 110"
Grille turned sideways on doors over 35-1/4" wide
Extra charges will apply for doors over 96" in height
- Charcoal fiberglass insect screening
- Standard push button handle
- 1-7/8" .050 side adjustable channel - 3 hinges
- 1-7/8" .050 bottom adjustment channel
- Extruded amplimesh 3/16" aluminum grille
- Precision SAFEGUARD packaging - complete with hardware

Standard Finishes

- Adobe, almond, bronze or white powder coated
- Satin anodized

Options

- Custom size
- Kick plate
- Pet door

Features

- 2-1/8" x 3/4" .050 Extruded aluminum frame, adjusts up to 1" wide and 1-3/4" high
- Standard 12" embossed .024 aluminum kickplate
- Standard sizes
2'6" x 6'8" (29-1/4" x 79-1/4")
2'8" x 6'8" (31-1/4" x 79-1/4")
3'0" x 6'8" (35-1/4" x 79-1/4")
- Custom widths 24" up to 47-7/8", heights up to 110"
Extra charges will apply for doors over 96" in height
- Charcoal fiberglass insect screening
- Standard push button handle
- 1-7/8" .050 side adjustment channel - 3 hinges
- 1-7/8" .050 bottom adjustment channel
- Standard fiesta expanded aluminum grille
- Precision SAFEGUARD packaging - complete with hardware

Standard Finishes

- Adobe, almond, black, bronze or white powder coated
- Bronze or satin anodized
- Mill

Options

- Custom size
- Handle upgrade
- Kick plate
- Pet door
- Pre-hung kit
- Push bar
- Screen cloth upgrade

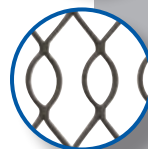

Extruded Aluminum Screen Door



3/0 = 36" • 2/8 = 32" • 2/6 = 30"

(Series 3517) SAFEGUARD

Features

- 2-1/8" x 3/4" .050 Extruded aluminum frame
- Standard 12" embossed .024 aluminum kickplate
- Standard sizes
2'6" x 6'8" (29-1/4" x 79-1/4")
2'8" x 6'8" (31-1/4" x 79-1/4")
3'0" x 6'8" (35-1/4" x 79-1/4")
- Custom widths 24" up to 41-1/4", heights up to 110"
Grille turned sideways on doors over 35-1/4" wide
Extra charges will apply for doors over 96" in height
- Charcoal fiberglass insect screening
- Standard push button handle
- 1-7/8" .050 side adjustable channel - 3 hinges
- 1-7/8" .050 bottom adjustment channel
- Extruded amplimesh 3/16" aluminum grille
- Precision SAFEGUARD packaging - complete with hardware

Standard Finishes

- Adobe, almond, black, bronze or white powder coated
- Satin anodized

Options

- Custom size
- Handle upgrade
- Kick plate
- Pet door
- Pre-hung kit
- Push bar
- Screen cloth upgrade



Extruded Aluminum Screen Door

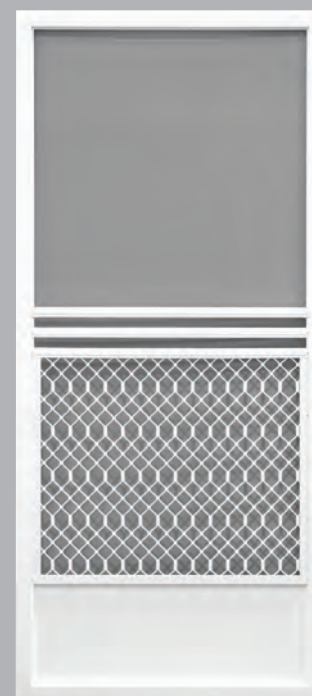

3/0 = 36" • 2/8 = 32" • 2/6 = 30"

Heavy Duty Extruded Aluminum Screen Door



3/0 = 36" • 2/8 = 32" • 2/6 = 30"

New

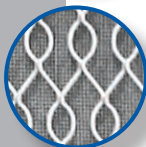

Features

- 2-1/8" x 3/4" .050 Extruded aluminum frame
- Standard 12" embossed .024 aluminum kickplate
- Standard sizes
2'6" x 6'8" (29-1/4" x 79-1/4")
2'8" x 6'8" (31-1/4" x 79-1/4")
3'0" x 6'8" (35-1/4" x 79-1/4")
- Custom widths 24" up to 41-1/4", heights up to 110"
Grille turned sideways on doors over 35-1/4" wide
Extra charges will apply for doors over 96" in height
- Charcoal fiberglass insect screening
- Standard push button handle
- 1-7/8" .050 side adjustable channel - 3 hinges
- 1-7/8" .050 bottom adjustment channel
- Extruded amplimesh 3/16" aluminum grille
- Precision SAFEGUARD packaging - complete with hardware

Standard Finishes

- Adobe, almond, black, bronze or white powder coated
- Satin anodized

Options

- Custom size
- Handle upgrade
- Kick plate
- Pet door
- Pre-hung kit
- Push bar
- Screen cloth upgrade

PROMO (Series 3210)

Economy Roll Form Steel Screen Door



3/0 = 36" • 2/8 = 32"



Features

- 2" x 7/8" .016 Roll form steel frame
- Standard 5-1/4" kickplate
- Standard sizes only - No custom sizes
2'8" x 6'8" (31-1/4" x 79-3/4")
3'0" x 6'8" (35-1/4" x 79-3/4")
- Charcoal fiberglass insect screening
- Single push bar
- Standard push button handle
- 1" bottom channel adjustment for proper height adjustment
- Precision SAFEGUARD packaging - complete with hardware

Standard Finishes

- Gray
- No other color options available for this door

Options

- No options available

Features

- 2" x 7/8" .016 Roll form steel frame
- Standard 5-1/4" kickplate
- Standard sizes only - No custom sizes
2'8" x 6'8" (31-1/8" x 79-3/4")
3'0" x 6'8" (35-1/8" x 79-3/4")
- Charcoal fiberglass insect screening
- Standard push button handle
- (3) Standard push bars
- 1-3/4" side adjustable channel with 2 hinges
- 1" bottom channel adjustment for proper height adjustment
- Provincial expanded metal grille
- Precision SAFEGUARD packaging - complete with hardware

Standard Finishes

- Bronze, gray or white
- No other color options available for this door

Options

- No options available

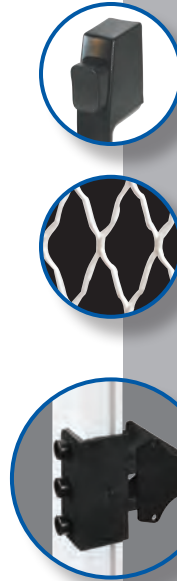

Economy Roll Form Steel Screen Door



3/0 = 36" • 2/8 = 32"

Features

- 2" x 7/8" .016 Roll form steel frame
- Standard 5-1/4" kickplate
- Standard sizes only - No custom sizes
2'8" x 6'8" (31-1/4" x 79-3/4")
3'0" x 6'8" (35-1/4" x 79-3/4")
- Charcoal fiberglass insect screening
- Single push bar
- Standard push button handle
- 1" bottom channel adjustment for proper height adjustment
- Precision SAFEGUARD packaging - complete with hardware

Standard Finishes

- Bronze, gray or white
- No other color options available for this door

Options

- No options available

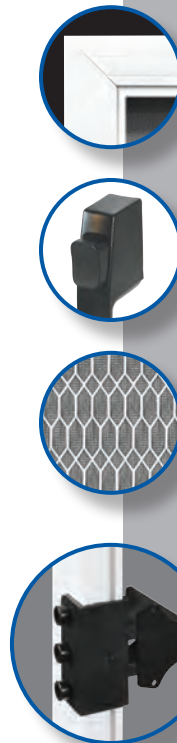



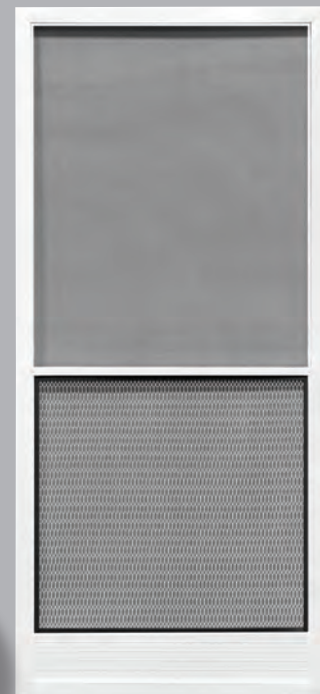



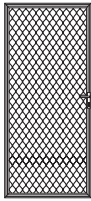
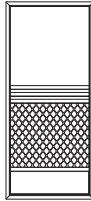
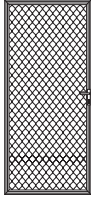

Economy Roll Form Steel Screen Door

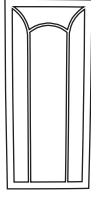
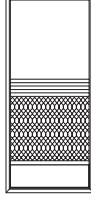
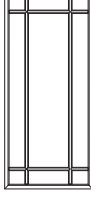
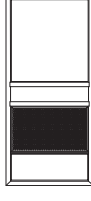

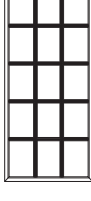
3/0 = 36" • 2/8 = 32"

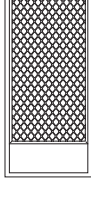
HINGED SCREEN DOORS Complete with Channels and Hardware

Name/ Series	Product Line	Description	Name/ Series	Product Line	Description
Centurion 3610 Page 2	D3003	 <p>2-7/8" x 7/8" .062 Extruded aluminum frame Available in 2'6", 2'8" & 3'0" x 6'8" Custom widths 24" up to 41-1/4", Heights up to 96" Extruded 1/4" aluminum centurion grille Adobe, almond, bronze or white Bronze or satin anodized No custom colors available for this door</p>	Santa Cruz 3521 Page 5	D3002	 <p>2-1/8" x 3/4" .050 Extruded aluminum frame Available in 2'6", 2'8" & 3'0" x 6'8" Custom widths 24" up to 41-1/4", Heights up to 110" * Extruded amplimesh 3/16" aluminum grille Adobe, almond, bronze or white Satin anodized</p>
Vanguard 3660 Page 2	D3003	 <p>2-7/8" x 7/8" .062 Extruded aluminum frame Available in 2'6", 2'8" & 3'0" x 6'8" Extruded amplimesh grille Bronze or white No custom sizes or colors available for this door</p>	Fiesta 3530 Page 6	D3002	 <p>2-1/8" x 3/4" .050 Extruded aluminum frame Available in 2'6", 2'8" & 3'0" x 6'8" Custom widths 24" up to 47-7/8", Heights up to 110" * Empress expanded aluminum heavy duty grille with metal grille surround Adobe, almond, black, bronze or white Bronze or satin anodized; mill</p>
Athens 3550 Page 3	D3002	 <p>2-7/8" x 7/8" .062 Extruded aluminum frame Available in 3'0" x 6'8" only Heavy duty steel architectural arched insert Almond, bronze or white No custom sizes or colors available for this door</p>	Safeguard 3517 Page 6	D3002	 <p>2-1/8" x 3/4" .050 Extruded aluminum frame Available in 2'6", 2'8" & 3'0" x 6'8" Custom widths 24" up to 41-1/4", Heights up to 110" * Extruded amplimesh 3/16" aluminum grille Adobe, almond, black, bronze or white Satin anodized</p>
Brighton 3525 Page 3	D3002	 <p>2-1/8" x 3/4" .050 Extruded aluminum frame Available in 2'6", 2'8" & 3'0" x 6'8" Custom widths 24" up to 47-7/8", Heights up to 110" * 1" Wide sculptured diamond lite grid pattern Adobe, almond, black, bronze or white</p>	Oceanside 3540 Page 7	D3002	 <p>2-1/8" x 3/4" .050 Extruded aluminum frame Available in 2'6", 2'8" & 3'0" x 6'8" Custom widths 24" up to 41-1/4", Heights up to 110" * Extruded amplimesh 3/16" aluminum grille Adobe, almond, black, bronze or white Satin anodized</p>
Clearview 3510 Page 4	D3002	 <p>2-1/8" x 3/4" .050 Extruded aluminum frame Available in 2'6", 2'8" & 3'0" x 6'8" Custom widths: 29" up to 47-7/8", Heights up to 110" * Standard 6" embossed .024 Alum. kickplate Adobe, almond, black, bronze or white Bronze or Satin anodized</p>	Promo 3210 Page 7	D3000	 <p>2" x 7/8" Roll form steel frame Available in 2'8" & 3'0" x 6'8" Single push bar Standard 5-1/4" embossed kickplate Gray No custom sizes or colors available for this door</p>
Colonade 3520 Page 4	D3002	 <p>2-1/8" x 3/4" .050 Extruded aluminum frame Available in 2'6", 2'8" & 3'0" x 6'8" Custom widths 29" up to 47-7/8", Heights up to 120" * 1" Wide sculpted 15 lite grid pattern Adobe, almond, black, bronze or white</p>	Provencial 3480 Page 8	D3001	 <p>2" x 7/8" Roll form steel frame (3) Standard push bars Standard 5-1/4" kickplate Available in 2'8" & 3'0" x 6'8" Bronze, gray or white No custom sizes or colors available for this door</p>
Santa Cruz Full Grille 3522 Page 5	D3002	 <p>2-1/8" x 3/4" .050 Extruded aluminum frame Available in 2'6", 2'8" & 3'0" x 6'8" Extruded amplimesh 3/16" aluminum grille Custom widths 36" up to 41-1/4", Heights up to 81" Fiesta expanded aluminum grille Adobe, almond, bronze or white Satin anodized</p>	Capri 3230 Page 8	D3000	 <p>2" x 7/8" Roll form steel frame Available in 2'8" & 3'0" x 6'8" Single push bar Standard 5-1/4" kickplate Bronze, gray or white No custom sizes or colors available for this door</p>

**Extra charges will apply for doors over 96" in height*

HINGED SCREEN DOOR

Custom options (add-ons) for extruded aluminum doors

Product Line D9999 for all options on this page

Option	Option Code	Description
Frame	OP-1PB-1	Install 1 each #288PB – 1-1/8" Extruded push bar (up to 3 push bars)
	OP-ADDKPLATE-9	Install a 9" kickplate in place of stock kickplate
	OP-ADDKPLATE-12	Install a 12" kickplate in place of stock kickplate
	OP-ADDKPLATE-20	Install a 20" kickplate in place of stock kickplate
	OP-SWSLOT4HNDL	Special placement security door lock (Centurion only)
Handle	2960xx	Add new designer hardware (extruded doors only) Available colors (replace xx): AB, BK, BR, BZ, SN & WH
	2965	Cylinders keyed alike (Centurion only)
Hinge	OP-ADDSHINGE-1	Additional hinge to channel (special hinge placement on channel)
Pre-hung frame for aluminum doors	OP-PREHUNG	Available pre-installed on door only (available in satin, white or bronze)
Pet door	OP-PD-SWG-S	Install pet door centered – small
	OP-PD-SWG-M	Install pet door centered – medium
	OP-PD-SWG-L	Install pet door centered – large
	OP-PD-SWG-X	Install pet door centered – extra large
Screen cloth	OP-SC14CF	Charcoal fiber 18" x 14"
	OP-SC16BA	Brite silver aluminum 18" x 16"
	OP-SCPSBK	Black petscreen
	OP-SCSSCF	Charcoal sunscreen
	OP-SCSTBK	Black sun tex
	OP-SC16BV	Better view

See price list for additional "OP" options

See pages 11-13 for all available options choices.

Note: Not all options are available in every door style, see individual door pages for specific information.

SCREEN DOOR ACCESSORIES

Standard and deluxe series door hardware



DESIGNER HARDWARE

Standard lever handle for our .062" aluminum extruded deluxe security doors

Finish	Part No.	Product Line
Antique brass	2960AB	F3970
Black	2960BK	F3970
Brass	2960BR	F3970
Bronze	2960BZ	F3970
Satin nickel	2960SN	F3970
White	2960WH	F3970

Includes: Inside and outside lever assembly, mortise lock, key cylinder, spindle, strike box, strike plate, screws and installation instructions.

The Designer hardware pack does not include a closer, but a standard hardware pack is included automatically with every swinging door purchase at no extra charge. Please specify desired standard hardware color to coordinate with your new designer hardware.

In options and special instructions on order form – *Example: Satin nickel - Designer/Silver standard pack*



GEORGIAN DESIGNER HARDWARE (OP-HNDL2129)

Upgrade lever handle for our .050" aluminum extruded deluxe line

Finish	Part No.	Product Line
Black	2129BK	F3320
Brass	2129BR	F3320
Satin nickel	2129SN	F3320
White	2129WH	F3320

Includes: Outside lever assembly, inside latch assembly, spring pack deadbolt plate, strike, spindle, screws and installation instructions.

The Georgian hardware pack does not include a closer, but a standard hardware pack is included automatically with every swinging door purchase at no extra charge. Please specify desired standard hardware color to coordinate with your new designer hardware.

In options and special instructions on order form – *Example: Satin nickel - Georgian/Silver standard pack*



STANDARD HARDWARE KIT PACK

For .050" extruded and roll form screen doors

Finish	Part No.	Product Line
Adobe	2090AD	F3320
Almond	2090AL	F3320
Black	2090BK	F3320
Bronze	2090BZ	F3320
Silver	2090SL	F3320
White	2090WH	F3320

Includes: Push button handle, inside latch, closer, bracket, screws and installation instructions.

Above items and upgraded closures can be ordered separately. Contact customer service/order desk for more information.



Hardware Kit

Note: Color coordinated hardware pack is automatically included with screen door purchase. Handle color may be specified when ordering door.

SCREEN DOOR ACCESSORIES

Double door kits

ONE-PIECE SCREEN DOOR ASTRAGAL

Slide Bolt - 2891BK - Spring not included

Spring - 2891-S

Fits our extruded series screen doors only

(Does not work with any other door in our line)

For ease of installation and enhanced visual appearance. Precision has designed a double door astragal system for screen doors.

- Slide bolts are self contained and hidden from view. (Internal slide bolt 2891, 2891-S)
- Simple installation
- No unsightly slide bolts to install separately.
- Easy for the installer

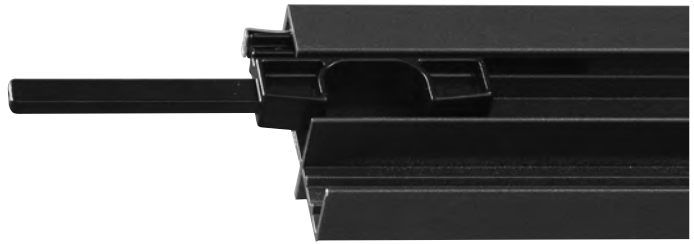

Finish	Product Line	Size - (84")	Size - (96")
Adobe	F3950	2920AD	2921AD
Almond	F3950	2920AL	2921AL
Black	F3950	2920BK	2921BK
Bronze	F3950	2920BZ	2921BZ
Bronze anodized	F3950	2920BA	2921BA
Satin anodized	F3950	2920SA	2921SA
White	F3950	2920WH	2921WH

DOUBLE SCREEN DOOR KITS

Fits all extruded & roll form screen doors

Finish	Product Line	Size - (84")	Size - (96")
Adobe	F3950	2911AD-84	2912AD-96
Almond	F3950	2911AL-84	2912AL-96
Black	F3950	2911BK-84	2912BK-96
Bronze	F3950	2911BZ-84	2912BZ-96
Bronze anodized	F3950	2911BA-84	2912BA-96
Satin anodized	F3950	2911SA-84	2912SA-96
White	F3950	2911WH-84	2912WH-96

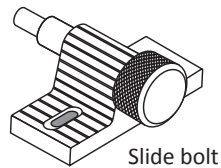

Slide bolt

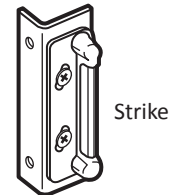

Strike

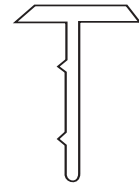

Actual size

Kit Includes:

- 1 Extruded astragal with screws
- 1 Special strike with shim
- 2 #2890 Slide-bolts (black only)
- 1 Instruction sheet

DOUBLE SECURITY SCREEN DOOR KITS

Fits Athens, Centurion & Vanguard

Finish	Product Line	Size - (84")	Size - (96")
Bronze	F3950	2976BZ-84	2981BZ-96
White	F3950	2976WH-84	2981WH-96

Kit Includes:

- 1 Extruded astragal with screws
- 1 Double door strike plate (brass)
- 2 #2890 Slide-bolts (black only)
- 1 Instruction sheet

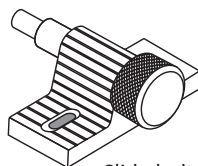

Slide bolt

French door strike plate



For Security Doors



Security door "T"-astragal

SCREEN DOOR ACCESSORIES

Bottom adjustment & hinge adjustment channels

B.A.C.= Bottom Adjustment Channel

H.S.A.C.= Hinge Side Adjustment Channel (comes standard with 3 hinges)

Finish	Product Line	Bottom channel 36" (BAC)	Hinge channel (HSAC) 81"	96"
--------	--------------	--------------------------	--------------------------	-----

Extruded Aluminum Doors

Adobe	F3320	2036AD	2041AD	2076AD
Almond	F3320	2036AL	2041AL	2076AL
Black	F3320	2036BK	2041BK	2076BK
Bronze	F3320	2036BZ	2041BZ	2076BZ
Bronze Anodized	F3320	2036BA	2041BA	2076BA
Satin Anodized	F3320	2036SA	2041SA	2076SA
White	F3320	2036WH	2041WH	2076WH

Extruded Aluminum Security Doors

Bronze	F3970	2946BZ	2953BZ
White	F3970	2946WH	2953WH

Black Vinyl Sweep	F3320	2975BK-750
--------------------------	-------	------------

Screen Door Hinge

Adobe	F3850	2175AD
Almond	F3850	2175AL
Bronze	F3850	2175BZ
White	F3850	2175WH

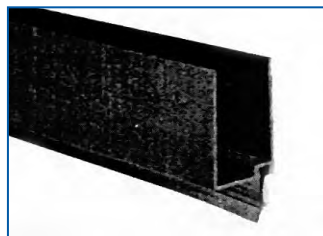

Extruded aluminum bottom adjustment channel with sweep

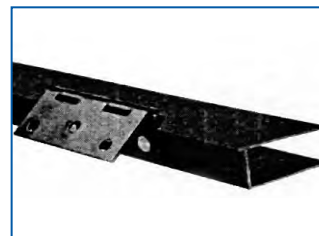

Extruded aluminum hinge side adjustment channel

Door type Steel	Product Line	Bottom channel 36" (BAC)	Hinge channel 81" (HSAC)
Bronze	F3320	2037BZ	2044BZ
Gray	F3320	2037GR	2044GR
White	F3320	2037WH	2044WH

*Standard with 2 hinges. 3rd. hinge, add \$4.00

SWINGING SCREEN DOOR WORKSHEET

Use this worksheet to help your customer in measuring and selecting their door

Phone (909) 379-0123

Customer Name _____

Job Name/PO# _____

Step 1

- Width Always First
- Measure opening width, inside jamb to inside jamb at three places (top, middle & bottom)
- Always in inches
- Always outside house looking in
- Take the largest of the three measurements

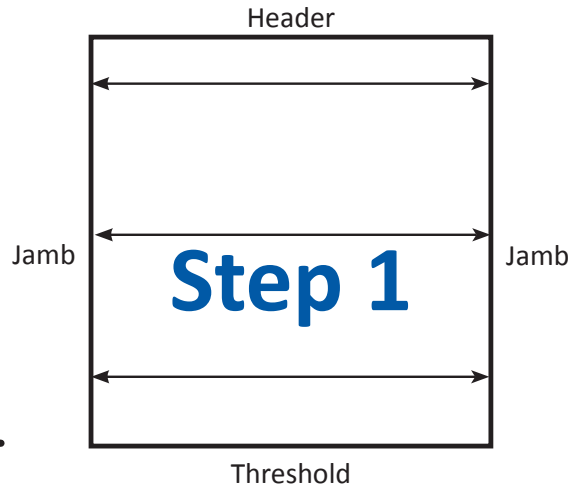

Step 2

- Measure opening height from threshold to header (inside to inside)
- Always in inches
- Always outside looking in

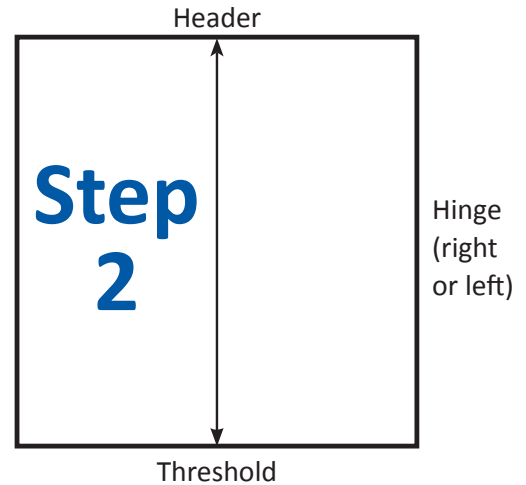

Step 3

- Measured Width _____ - 3/4" = _____ Net Size
- Measured Height _____ - 3/4" = _____ Net Size

Step 4

- Select Door, Color and Options
- If Pre-Hung frame needed specify hinge side (Right or Left) *(from outside looking in)*

DOOR SIZING CHART

Aluminum and Heavy Duty Steel Swinging Screen Doors

Door Series

Aluminum Security Door
Vanguard & Centurion

Extruded Aluminum
Athens

Extruded Aluminum
*Brighton, Fiesta, Safeguard,
Santa Cruz, Santa Cruz Full Grille,
Colonade, Clearview, Oceanside*

Roll Form
Provincial, Capri & Promo

	DOOR WIDTH			NET DOOR HEIGHT		
	Net door width	With hinge channel collapsed	With hinge channel extended	Without bottom channel	With bottom channel collapsed	With bottom channel extended
(36") 3/0=	35-1/4"	35-1/2"	36-1/4"	79-1/2"	79-3/4"	80-3/4"
(32") 2/8=	31-1/4"	31-1/2"	32-1/4"	79-1/2"	79-3/4"	80-3/4"
(30") 2/6=	29-1/4"	29-1/2"	30-1/4"	79-1/2"	79-3/4"	80-3/4"
(36") 3/0=	35-1/4"	35-1/2"	36-1/2"	79-1/4"	79-1/2"	80-5/8"
(32") 2/8=	31-1/4"	31-1/2"	32-1/2"	79-1/4"	79-1/2"	80-5/8"
(30") 2/6=	29-1/4"	29-1/2"	30-1/2"	79-1/4"	79-1/2"	80-5/8"
(36") 3/0=	35-1/8"	35-1/2"	36-3/8"	79-3/4"	79-3/4"	81"
(32") 2/8=	31-1/8"	31-1/2"	32-3/8"	79-3/4"	79-3/4"	81"

SECTION 2 / DOMESTIC STEEL SECURITY DOORS

PRODUCT	PAGE
Steel security doors	25-35
Steel security door custom options	36
Vineyard, Paradise, Impressions & Longevity door inserts.....	37
Steel security door list	38-39
Steel patio door & enclosure	40-42
Steel patio door & enclosure options	43
Steel patio door & enclosure list	44-45
Steel window guards	46-47
Steel window guard accessories.....	48
Steel security door mounting variations	49
LIT596 worksheet	50-53
Steel security door short worksheet	54

DOMESTIC STEEL SECURITY DOORS

This section includes photographs and specifications of Precision's line of steel security products. These products are manufactured at our Redlands, CA facility. All items are welded, assembled and finished using high quality raw materials and state of the art equipment. For a complete catalog of Precision products, or if you have any question regarding any Precision products or specifications, please contact your Precision representative or call Precision customer service.

Refer to the "Terms and Conditions" page for warranty information.

The pictures shown may illustrate optional finishes. Standard finishes & sizes for each item are shown on the products corresponding page.

Precision steel security doors come standard as surface mount. Refer to page 47 for mounting variations.

The standard sizes indicated in this section represent "industry standard" door openings.

Refer to the order forms on pages 48-51 or page 52 (compressed version).

Steel security door dimensions:

A. The net overall size, which includes a 1-1/4" sq. 3-piece mounting frame, is as follows:

Door Opening	Net Overall Size
2'6" x 6'8" (30" x 80")	2'9" x 6'9-3/4" (33" x 81-3/4")
2'8" x 6'8" (32" x 80")	2'11" x 6'9-3/4" (35" x 81-3/4")
3'0" x 6'8" (36" x 80")	3'3" x 6'9-3/4" (39" x 81-3/4")

B. When ordering surface mounted, custom size steel security doors: add 3" to the opening width & 1-3/4" to the opening height

C. Standard perforated metal is 24 gauge and is attached to the steel tube frame with stainless steel rivets.

Steel Master - 3812, Italian Leaf - 3824, English Ivy - 3829, Sonoma - 3830 dimensions:

A. The Net Overall Size, which includes a 1-1/2" sq. 1-piece, 3-sided mounting frame, is as follows:

Door Opening	Net Overall Size
2'6" x 6'8" (30" x 80")	2'9-1/2" x 6'10" (33-1/2" x 82")
2'8" x 6'8" (32" x 80")	2'11-1/2" x 6'10" (35-1/2" x 82")
3'0" x 6'8" (36" x 80")	3'3-1/2" x 6'10" (39-1/2" x 82")

B. When ordering surface mounted, custom size Steel Masters: add 3 1/2" to the opening width & 2" to the opening height

C. Standard perforated metal is 24 gauge and is attached to the steel tube frame with stainless steel rivets.

Refer to page 34 for options.

Product availability limited to stock on hand.

Custom doors require a (4) four week lead time on average.

A signed confirmation must be received by Precision before any custom items are scheduled for production. Precision is not responsible for any errors and/or omissions in customer verified information.

On products with perforated metal that is welded in place on special request, the perforated metal may experience deformation and the item may have areas of insufficient finish.

To prevent oxidation (rust), touch up any scratches, chips, etc. with a quality rust inhibiting paint as soon as possible. In order to maintain a rust free finish, regularly inspect and re-paint as needed. In exposed, damp or coastal areas annual painting is recommended.

NEW STEEL MESH OPTIONS



- Offers increased airflow
- Improves visibility
- Removable screen mesh for easy replacement



Actual size

OP-HEXPERFSCREEN22

22 gauge hex perf option with screen
Up to 48" x 84"
79% Open area

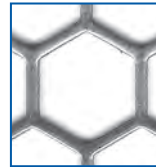

Actual size

OP-HEXPERFSCREEN16 (Shown)

16 gauge hex perf option with screen
Up to 46" x 96"
79% Open area



Actual size

OP-CLOVLEAFPERFSCREEN-22

22 gauge cloverleaf perf option with screen
Up to 48" x 84"
Contrasting color mesh available
50% Open area



Actual size

OP-GRECIANPERFSCREEN-22

22 gauge grecian perf option with screen
Up to 48" x 84"
Contrasting color mesh available
35% Open area



Each door includes a screen panel with 18-16 charcoal screen mesh.

ASK ABOUT CUSTOM WATER JET CUT PATTERNS

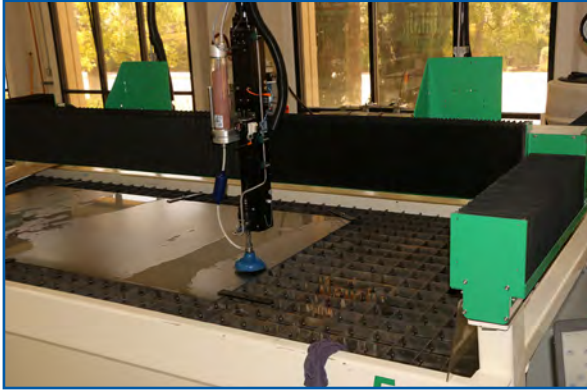

Precision can help design* and manufacture custom panels for security doors, fencing & gates.

DESIGN INSPIRATION

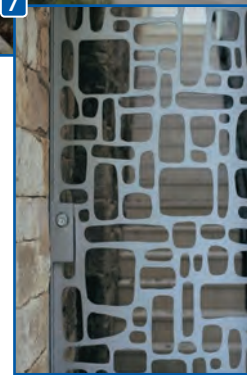
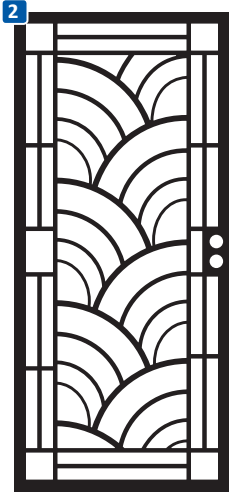
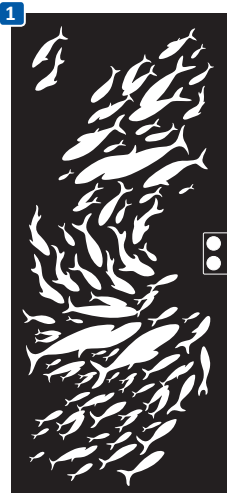

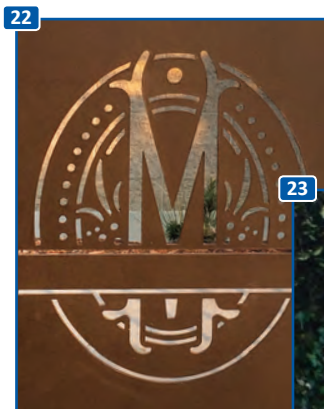
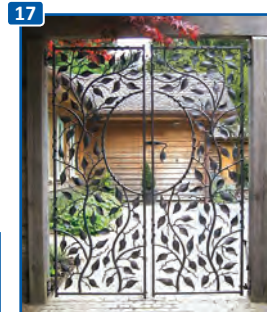
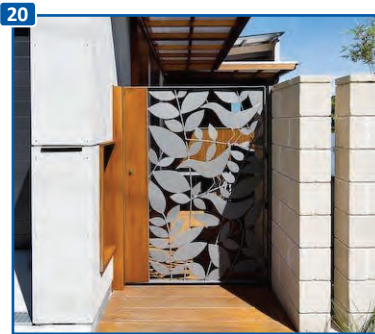
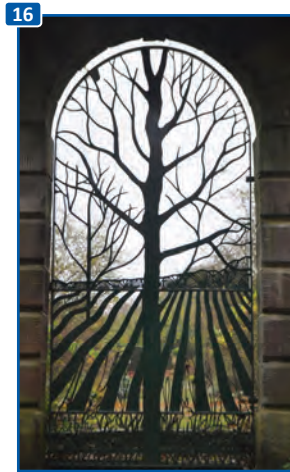
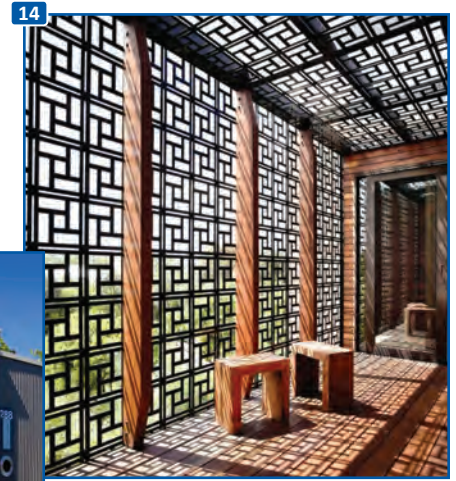
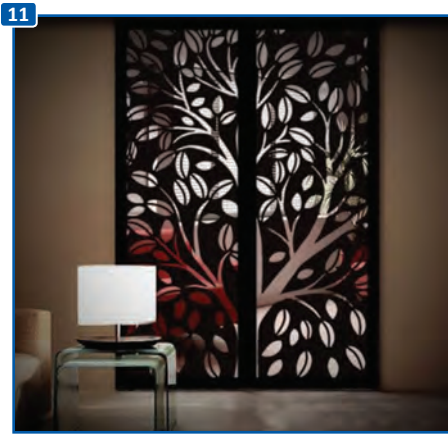

23

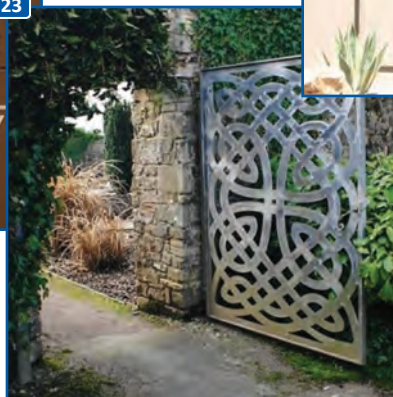

NEW WATER JET — DOORS —

- Door series are built to order
- Water jet unique designs are cut from 1/8 in. steel
- Standard and custom sizes available
- Doors available in adobe, almond, black, bronze or white
- Contrasting color mesh (as shown) is an upgrade for an additional charge

ABERDEEN



6830 - Single
7830 - Double

ARIZONA



6875 - Single
7875 - Double

BEACON



6800 - Single
7800 - Double

CALYPSO



6833 - Single
7833 - Double

DYNASTY



6845 - Single
7845 - Double

ECLIPSE



6812 - Single
7812 - Double

FIORI



6840 - Single
7840 - Double

GEOTIC



6876 - Single
7876 - Double

LAVENDER



6809 - Single
7809 - Double

MONACO



6807 - Single
7807 - Double

NOUVEAU



6835 - Single
7835 - Double

PORTICO



6802 - Single
7802 - Double

SHERWOOD



6803 - Single
7803 - Double

STARFIRE



6801 - Single
7801 - Double

STEPLOCK



6810 - Single
7810 - Double

SURREY



6839 - Single
7839 - Double

VICTORIAN



6806 - Single
7806 - Double

TEST SPECIFICATIONS (Steel Security Doors)

Classification

For the purposes of this standard, door assemblies and components are classified by their relative resistance to forced entry. Four classes of door assemblies and components are established, from class I, with the lowest level of resistance, to class IV, with the highest level of resistance (**Most Precision doors test as a 2 or 3**).

Class I “Light”. For screen door assemblies and components which provide a minimum of physical security. Typically for use in areas where forced entry is unlikely.

2.1.2 Class II “Medium”. For screen door assemblies and components which provide a moderate level of physical security. Typically for use in areas with some access and will allow some deterrent against forced entry.

2.1.3 Class III “Heavy”. For screen door assemblies and components which provide a medium level of physical security. Typically for use in areas with easy access and will act as a deterrent against forced entry.

2.1.4 Class IV “High Security”. For screen door assemblies and components which provide relatively high level of physical security. For use in areas that require a high access denial barrier.

Testing Requirements

TEST DESC.	TEST	METHO D	ACCEPT CRITERIA	MEASURED PARAMETER	TEST RESULT VALUES			
					CLASS I LIGHT	CLASS II MEDIUM	CLASS III HEAVY	CLASS IV HI SECURITY
BOLT PROJECTION STRIKE HOLE	4.2	5.6	6.2.8	PROJECTION SIZE	14.3 mm (9/16 in) *	14.3 mm (9/16 in) *	17.5 mm (11/16 in) *	17.5 mm (11/16 in) *
BOLT PRESSURE	4.3	5.7	6.2.10	RESISTANCE	670 N (150 lbf)	670 N (150 lbf)	670 N (150 lbf)	670 N (150 lbf)
JAMB/WALL STIFFNESS	4.4	5.8	6.2.11	FORCE TO SPREAD	6K N (1,350 lbf)	8K N (1.8K lbf)	16K N (3.6K lbf)	22K N (4.95K lbf)
				INCREASE IN LOCK-FRONT TO STRIKE SPACE	9.5 mm (3/8 in)	9.5 mm (3/8 in)	13 mm (1/2 in)	13 mm (1/2 in)
KNOB IMPACT**	4.5	5.9	6.2.12	RESISTANCE -75 LBF-FT (100 J) IMPACT	ONE BLOW	TWO BLOWS	FIVE BLOWS	TEN BLOWS
CYLINDER CORE TENSION	4.6	5.10	6.2.13	RESISTANCE	1.3K N (290 lbf)	4.8K N (1.08K lbf)	11K N (2.47K lbf)	11K N (2.47K lbf)
CYLINDER BODY TENSION*	4.7	5.11	6.2.14	RESISTANCE	---	---	---	16K N (3.6K lbf)
KNOB TORQUE***	4.8	5.12	6.2.15	RESISTANCE	25 Nm (18.5 lbf-ft)	50 Nm (37 lbf-ft)	110 Nm (81 lbf-ft)	160 Nm (118 lbf-ft)
CYLINDER TORQUE****	4.9	5.13	6.2.16	RESISTANCE	---	---	100 Nm (81 lbf-ft)	160 Nm (118 lbf-ft)
CYLINDER IMPACT*****	4.10	5.14	6.2.16	RESISTANCE -75 LBF-FT (100 J) IMPACT	---	---	FIVE BLOWS	TEN BLOWS
DOOR IMPACT	4.11	5.15	6.2.17	IMPACT RESISTANCE AT CENTER AND PANEL	2 BLOWS of 80 J (59 ft lbf)	CLASS I REQUIREMENTS PLUS 2 BLOWS OF 120 J (89 ft lbf)	CLASS II REQUIREMENTS PLUS 2 BLOWS OF 160 J (118 ft lbf)	CLASS III REQUIREMENTS PLUS 2 BLOWS OF 200 J (148 ft lbf)
				IMPACT RESISTANCE OF GLAZING-75 LBF-FT (100 J) IMPACT	ONE BLOW	TWO BLOWS	FIVE BLOWS	TEN BLOWS
HINGE PIN REMOVAL****	4.12	5.16	6.2.19	RESISTANCE	225 N (50 lbf)	225 N (50 lbf)	900 N (200 lbf)	900 N (200 lbf)
HINGE IMPACT	4.13	5.17	6.2.21	IMPACT RESISTANCE AT HINGE	2 BLOWS of 80 J (59 ft lbf)	CLASS I REQUIREMENTS PLUS 2 BLOWS OF 120 J (89 ft lbf)	CLASS II REQUIREMENTS PLUS 2 BLOWS OF 160 J (118 ft lbf)	CLASS III REQUIREMENTS PLUS 2 BLOWS OF 200 J (148 ft lbf)
BOLT IMPACT	4.14	5.18	6.2.22	IMPACT RESISTANCE AT BOLT	2 BLOWS of 80 J (59 ft lbf)	CLASS I REQUIREMENTS PLUS 2 BLOWS OF 120 J (89 ft lbf)	CLASS II REQUIREMENTS PLUS 2 BLOWS OF 160 J (118 ft lbf)	CLASS III REQUIREMENTS PLUS 2 BLOWS OF 200 J (148 ft lbf)
FORCED ENTRY RESISTANCE	4.15	5.19	6.2.23	PRYING RESISTANCE	LOAD A 30LBF (13.6KG) LOAD B 75LBF (34KG) LOAD C 30LBF (13.6KG)	LOAD A 75LBF (34.6KG) LOAD B 150LBF (68KG) LOAD C 75LBF (34.6KG)	LOAD A 150LBF (68KG) LOAD B 300LBF (136KG) LOAD C 150LBF (68KG)	LOAD A 30LBF (13.6KG) LOAD B 75LBF (34KG) LOAD C 30LBF (13.6KG)

Forced Entry Resistance Loads

CLASS	LOAD A	LOAD B	LOAD C
Grade 1	30 lbf (13.6kg)	75 lbf (34kg)	30 lbf (13.6kg)
Grade 2	75 lbf (34.6kg)	150 lbf (68kg)	75 lbf (34kg)
Grade 3	150 lbf (68kg)	300 lbf (136 kg)	150 lbf (68kg)
Grade 4	225 lbf (102kg)	450 lbf (204 kg)	225 lbf (102kg)

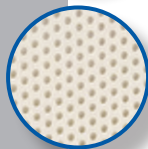

Features

- Standard sizes:
2'6" x 6'8" (33" x 81-3/4" Net overall frame)
2'8" x 6'8" (35" x 81-3/4" Net overall frame)
3'0" x 6'8" (39" x 81-3/4" Net overall frame)
- Custom sizes available
- 1-1/4" sq. x 18 Ga. 3-piece steel mounting frame
- 1" sq. x 18 Ga. steel door frame
- 1/2" sq. x 18 Ga. steel pickets
- "Hummingbird" insert is water jet cut from 1/8" steel and is welded in place. **Must specify handing.**
- For optional insert designs - refer to page 35
- Double hole lock-box w/ 2-1/8" bore & 2-3/8" backset
- Continuous 1/8" x 3/4" lock side "tamper guard"
- Tamper proof hinges
- 24 Ga. perforated steel mesh for extra security
- Contrasting color mesh (as shown) is an upgrade for an additional charge
- Precision SAFEGUARD packaging - complete with one-way mounting screws

Stocked Finishes

- Almond or white with matching powder coated perforated steel mesh

LONGEVITY (Series 3834)

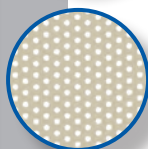

Features

- This door series is built to order
- Standard size:
3'0" x 6'8" (39" x 81-3/4" Net overall frame)
- Custom sizes available
- 1-1/4" sq. x 18 Ga. pre-hung steel mounting frame
- 1" x 2" x 18 Ga. steel door frame
- 5/8" sq. x 18 Ga. vertical pickets
- Removable "Longevity" insert, water jet cut from 1/8" steel
- Signature design at top and bottom
- For optional insert designs - refer to page 35
- Double hole lock-box w/ 2-1/8" bore & 2-3/8" backset
- Continuous 1/8" x 3/4" lock side "tamper guard"
- Tamper proof hinges
- 24 Ga. perforated steel mesh for extra security
- Non-handed
- Contrasting color mesh (as shown) is an upgrade for an additional charge
- Precision SAFEGUARD packaging - complete with one-way mounting screws

Stocked Finishes

- Built to order

Features

- This door series is built to order
- Standard size:
3'0" x 6'8" (39" x 81-3/4" Net overall frame)
- Custom sizes available
- 1-1/4" sq. x 18 Ga. 3-piece mounting frame
- 1" sq. x 18 Ga. steel door frame
- "Vineyard" design, water jet cut from 1/8" steel
- Removable "Welcome" insert, water jet cut from 1/8" steel
- For optional insert designs - refer to page 35
- Double hole lock-box w/ 2-1/8" bore & 2-3/8" backset
- Continuous 1/8" x 3/4" lock side "tamper guard"
- Tamper proof hinges
- 24 Ga. perforated steel mesh for extra security
- Non-handed
- Contrasting color mesh (as shown) is an upgrade for an additional charge
- **Custom design services available**
- Precision SAFEGUARD packaging - complete with one-way mounting screws

Stocked Finishes

- Built to order

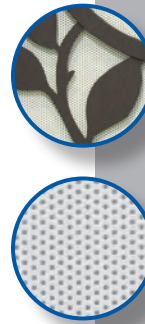

Water Jet Cut Panel



(Series 3826) VINEYARD FULL

Features

- This door series is built to order
- Standard size:
3'0" x 6'8" (39" x 81-3/4" Net overall frame)
- Custom sizes available
- 1-1/4" sq. x 18 Ga. 3-piece mounting frame
- 1" sq. x 18 Ga. steel door frame
- "Vineyard" design, water jet cut from 1/8" steel
- Double hole lock-box w/ 2-1/8" bore & 2-3/8" backset
- Continuous 1/8" x 3/4" lock side "tamper guard"
- Tamper proof hinges
- 24 Ga. perforated steel mesh for extra security
- Non-handed
- Contrasting color mesh (as shown) is an upgrade for an additional charge
- **Custom design services available**
- Precision SAFEGUARD packaging - complete with one-way mounting screws

Stocked Finishes

- Built to order



Water Jet Cut Panel



Water Jet Cut Panel

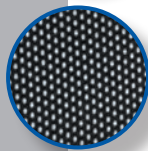

Features

- This door series is built to order
- Standard sizes:
2'6" x 6'8" (33" x 81-3/4" Net overall frame)
2'8" x 6'8" (35" x 81-3/4" Net overall frame)
3'0" x 6'8" (39" x 81-3/4" Net overall frame)
- Custom sizes available
- 1-1/4" sq. x 18 Ga. 3-piece steel mounting frame
- 1" sq. x 18 Ga. steel door frame
- 1/2" sq. x 18 Ga. steel pickets
- Removable "Welcome" insert, water jet cut from 1/8" steel
- For optional insert designs - refer to page 35
- Double hole lock-box w/ 2-1/8" bore & 2-3/8" backset
- Continuous 1/8" x 3/4" lock side "tamper guard"
- Tamper proof hinges
- 24 Ga. perforated steel mesh for extra security
- Non-handed
- Contrasting color mesh (as shown) is an upgrade for an additional charge
- Precision SAFEGUARD packaging - complete with one-way mounting screws

Stocked Finishes

- Built to order

SOUTHWEST (Series 3837)

Water Jet Cut Panel

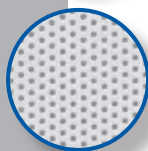

Features

- This door series is built to order
- Standard size:
3'0" x 6'8" (39" x 81-3/4" Net overall frame)
- Custom sizes available
- 1-1/4" sq. x 18 Ga. 3-piece mounting frame
- 1" sq. x 18 Ga. steel door frame
- "Southwest" design, water jet cut from 1/8" steel
- Double hole lock-box w/ 2-1/8" bore & 2-3/8" backset
- Continuous 1/8" x 3/4" lock side "tamper guard"
- Tamper proof hinges
- 24 Ga. perforated steel mesh for extra security
- Non-handed
- Contrasting color mesh (as shown) is an upgrade for an additional charge
- **Custom design services available**
- Precision SAFEGUARD packaging - complete with one-way mounting screws

Stocked Finishes

- Built to order

Features

- This door series is built to order
- Standard size:
3'0" x 6'8" (39" x 81-3/4" Net overall frame)
- Custom sizes available
- 1-1/4" sq. x 18 Ga. 3-piece mounting frame
- 1" sq. x 18 Ga. steel door frame
- "San Marino" design, water jet cut from 1/8" steel
- Double hole lock-box w/ 2-1/8" bore & 2-3/8" backset
- Continuous 1/8" x 3/4" lock side "tamper guard"
- Tamper proof hinges
- 24 Ga. perforated steel mesh for extra security
- Non-handed
- Contrasting color mesh (as shown) is an upgrade for an additional charge
- **Custom design services available**
- Precision SAFEGUARD packaging - complete with one-way mounting screws

Stocked Finishes

- Built to order



Water Jet Cut Panel



Features

- This door series is built to order
- Standard size:
3'0" x 6'8" (39" x 81-3/4" Net overall frame)
- Custom sizes available
- 1-1/4" sq. x 18 Ga. 3-piece mounting frame
- 1" sq. x 18 Ga. steel door frame
- "Deco" design, water jet cut from 1/8" steel
- Double hole lock-box w/ 2-1/8" bore & 2-3/8" backset
- Continuous 1/8" x 3/4" lock side "tamper guard"
- Tamper proof hinges
- 24 Ga. perforated steel mesh for extra security
- Non-handed
- Contrasting color mesh (as shown) is an upgrade for an additional charge
- **Custom design services available**
- Precision SAFEGUARD packaging - complete with one-way mounting screws

Stocked Finishes

- Built to order



Water Jet Cut Panel





Features

- This door series is built to order
- Custom sizes available
- 1-1/4" sq. x 18 Ga. 3-piece mounting frame
- 1" x 2" x 18 Ga. steel door frame
- 1/2" sq. x 18 Ga. vertical steel pickets
- 3/4" sq. x 18 Ga. horizontal steel pickets
- Double hole lock-box w/ 2-1/8" bore & 2-3/8" backset
- Continuous 1/8" x 3/4" lock side "tamper guard"
- Tamper proof hinges
- 24 Ga. perforated steel mesh for extra security
- Non-handed
- Contrasting color mesh (as shown) is an upgrade for an additional charge
- Precision SAFEGUARD packaging - complete with one-way mounting screws

Stocked Finishes

- Built to order

ITALIAN LEAF (Series 3824)

Heavy Duty



Features

- **1-1/2" sq. x 16 Ga. 1-piece, 3-sided steel mounting frame**
- 1" sq. x 18 Ga. steel door frame
- 1" sq. x 18 Ga. horizontal pickets
- 5/8" sq. x 18 Ga. vertical pickets
- 1/4" x 12" steel scrolls w/leaves
- Decorative collars on pickets
- Double hole lock-box, w/ 2-1/8" bore & 2-3/8" backset
- **Lock ring guard**
- Continuous 1/8" x 1" steel top & lock side "tamper guard"
- Tamper proof hinges
- 24 Ga. perforated steel mesh for extra security
- **Specify left or right side hinges (from outside looking in)**
- Contrasting color mesh (as shown) is an upgrade for an additional charge
- Precision SAFEGUARD packaging - complete with one-way mounting screws

Stocked Finishes

- Built to order

Features

- 1-1/2" sq. x 16 Ga. 1-piece, 3-sided steel mounting frame
- 1" sq. x 18 Ga. steel door frame
- 3/4" sq. x 18 Ga. horizontal steel pickets
- 5/8" sq. x 18 Ga. vertical & arched pickets
- Aluminum ivy casting at center
- Decorative collars on pickets
- Double hole lock-box w/ 2-1/8" bore & 2-3/8" backset
- **Lock ring guard**
- Continuous 1/8" x 1" steel top & lock side "tamper guard"
- Tamper proof hinges
- 24 Ga. perforated steel mesh for extra security
- **Specify left or right side hinges (from outside looking in)**
- Contrasting color mesh is an upgrade for an additional charge
- **High air flow hex perf mesh (as shown) is an upgrade for an additional charge**
- Precision SAFEGUARD packaging - complete with one-way mounting screws

Stocked Finishes

- Built to order

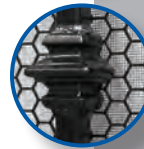

Heavy Duty



Features

- 1-1/2" sq. x 16 Ga. 1-piece, 3-sided steel mounting frame
- 1" sq. x 18 Ga. steel door frame
- 3/4" sq. x 18 Ga. horizontal steel pickets
- 5/8" sq. x 18 Ga. vertical & arched pickets
- Aluminum grape vine casting at center
- Aluminum grape vine casting at top
- Double hole lock-box w/ 2-1/8" bore & 2-3/8" backset
- **Lock ring guard**
- Continuous 1/8" x 1" steel top & lock side "tamper guard"
- Tamper proof hinges
- 24 Ga. perforated steel mesh for extra security
- **Specify left or right side hinges (from outside looking in)**
- Contrasting color mesh (as shown) is an upgrade for an additional charge
- Precision SAFEGUARD packaging - complete with one-way mounting screws

Stocked Finishes

- Built to order

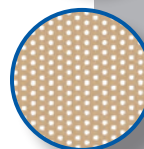

Heavy Duty



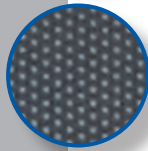

Features

- Standard sizes:
 - 2'6" x 6'8" (33" x 81-3/4" Net overall frame)
 - 2'8" x 6'8" (35" x 81-3/4" Net overall frame)
 - 3'0" x 6'8" (39" x 81-3/4" Net overall frame)
- Custom sizes available
- 1-1/4" sq. x 18 Ga. 3-piece steel mounting frame
- 1" sq. x 18 Ga. steel door frame
- Double hole lock-box w/ 2-1/8" bore & 2-3/8" backset
- Continuous 1/8" x 3/4" lock side "tamper guard"
- Tamper proof hinges
- 24 Ga. perforated steel mesh for extra security
- 3/4" Thick pine wood, colonial pattern with light oak stain insert
- Non-handed
- Contrasting color mesh is an upgrade for an additional charge
- Precision SAFEGUARD packaging - complete with one-way mounting screws

Stocked Finishes

- Frame only: Almond, black, bronze or white powder coated
Wood insert is only available in oak stain

DAKOTA (Series 3814)

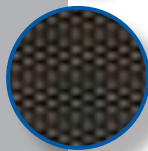
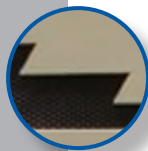

Features

- Standard sizes:
 - 2'6" x 6'8" (33" x 81-3/4" Net overall frame)
 - 2'8" x 6'8" (35" x 81-3/4" Net overall frame)
 - 3'0" x 6'8" (39" x 81-3/4" Net overall frame)
- Custom sizes available
- 1-1/4" sq. x 18 Ga. 3-piece steel mounting frame
- 1" x 2" x 16 Ga. steel door frame
- 1" sq. x 18 Ga. steel horizontal tubes at lock-box, top, & bottom
- 1/2" sq. x 18 Ga. vertical steel pickets
- 1/2" sq. x 18 Ga. horizontal steel pickets at top, center & bottom
- 11 Ga. Dakota designs at top, center, & bottom
- Double hole lock-box w/ 2-1/8" bore & 2-3/8" backset
- Continuous 1/8" x 3/4" lock side "tamper guard"
- Tamper proof hinges
- 24 Ga. perforated steel mesh for extra security
- Non-handed
- Contrasting color mesh (as shown) is an upgrade for an additional charge
- Precision SAFEGUARD packaging - complete with one-way mounting screws

Stocked Finishes

- Adobe or almond with matching powder coated perforated steel mesh

Features

- Standard sizes:
2'6" x 6'8" (33" x 81-3/4" Net overall frame)
2'8" x 6'8" (35" x 81-3/4" Net overall frame)
3'0" x 6'8" (39" x 81-3/4" Net overall frame)
- Custom sizes available
- 1-1/4" sq. x 18 Ga. 3-piece steel mounting frame
- 1" sq. x 18 Ga. steel door frame
- 1" sq. x 18 Ga. steel horizontal tubes at lock-box
- 1/2" sq. x 18 Ga. vertical steel pickets (2 twisted - 3 straight)
- Ten signature aluminum castings
- Double hole lock-box w/ 2-1/8" bore & 2-3/8" backset
- Continuous 1/8" x 3/4" lock side "tamper guard"
- Tamper proof hinges
- 24 Ga. perforated steel mesh for extra security
- Non-handed
- Contrasting color mesh (as shown) is an upgrade for an additional charge
- Precision SAFEGUARD packaging - complete with one-way mounting screws

Stocked Finishes

- Black or white with matching powder coated perforated steel mesh

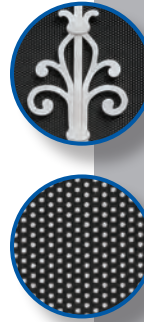

Features

- Standard sizes:
2'6" x 6'8" (33" x 81-3/4" Net overall frame)
2'8" x 6'8" (35" x 81-3/4" Net overall frame)
3'0" x 6'8" (39" x 81-3/4" Net overall frame)
- Custom sizes available
- 1-1/4" sq. x 18 Ga. 3-piece mounting frame
- 1" sq. x 18 Ga. steel door frame
- 1/2" sq. x 18 Ga. vertical steel pickets
- 1/2" sq. x 18 Ga. horizontal steel pickets
- Two signature aluminum castings
- Double hole lock-box w/ 2-1/8" bore & 2-3/8" backset
- Continuous 1/8" x 3/4" lock side "tamper guard"
- Tamper proof hinges
- 24 Ga. perforated steel mesh for extra security
- Non-handed
- Contrasting color mesh (as shown) is an upgrade for an additional charge
- Precision SAFEGUARD packaging - complete with one-way mounting screws

Stocked Finishes

- Adobe, almond, black, bronze or white with matching powder coated perforated steel mesh

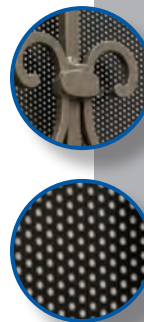

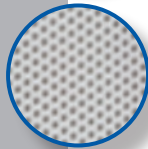

Features

- Standard sizes:
 - 2'6" x 6'8" (33" x 81-3/4" Net overall frame)
 - 2'8" x 6'8" (35" x 81-3/4" Net overall frame)
 - 3'0" x 6'8" (39" x 81-3/4" Net overall frame)
- Custom sizes available
- 1-1/4" sq. x 18 Ga. 3-piece steel mounting frame
- 1" sq. x 18 Ga. steel door frame
- 1/2" sq. x 18 Ga. vertical steel pickets
- 1/2" sq. x 18 Ga. horizontal steel pickets
- 1/8" Thick x 1/2" wide steel scroll design
- Double hole lock-box w/ 2-1/8" bore & 2-3/8" backset
- Continuous 1/8" x 3/4" lock side "tamper guard"
- Tamper proof hinges
- 24 Ga. perforated steel mesh for extra security
- Non-handed
- Contrasting color mesh (as shown) is an upgrade for an additional charge
- Precision SAFEGUARD packaging - complete with one-way mounting screws

Stocked Finishes

- Black, bronze or white with matching powder coated perforated steel mesh

MADRID (Series 3806)

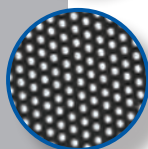

Features

- Standard sizes:
 - 2'6" x 6'8" (33" x 81-3/4" Net overall frame)
 - 2'8" x 6'8" (35" x 81-3/4" Net overall frame)
 - 3'0" x 6'8" (39" x 81-3/4" Net overall frame)
- Custom sizes available
- 1-1/4" sq. x 18 Ga. 3-piece steel mounting frame
- 1" sq. x 18 Ga. steel door frame
- 1" sq. x 18 Ga. steel horizontal tubes at lock-box
- 1/2" sq. x 18 Ga. vertical steel pickets (3 twisted - 2 straight)
- 1/2" sq. x 18 Ga. horizontal steel pickets
- 1/8" thick x 1/2" wide steel scroll designs
- Double hole lock-box w/ 2-1/8" bore & 2-3/8" backset
- Continuous 1/8" x 3/4" lock side "tamper guard"
- Tamper proof hinges
- 24 Ga. perforated steel mesh for extra security
- Non-handed
- Contrasting color mesh is an upgrade for an additional charge
- Precision SAFEGUARD packaging - complete with one-way mounting screws

Stocked Finishes

- Black or white with matching powder coated perforated steel mesh

Features

- Standard sizes:
2'6" x 6'8" (33-1/2" x 82" Net overall frame)
2'8" x 6'8" (35-1/2" x 82" Net overall frame)
3'0" x 6'8" (39-1/2" x 82" Net overall frame)
- Custom sizes available
- **1-1/2" sq. x 16 Ga. one piece - 3 sided steel mounting frame**
- 1" sq. x 18 Ga. steel door frame
- 5/8" sq. x 18 Ga. vertical steel pickets
- 3/8" sq. x 18 Ga. horizontal steel pickets
- 1/8" thick x 1/2" wide steel scroll designs
- Double hole lock-box w/ 2-1/8" bore & 2-3/8" backset
- **Lock ring guard**
- Continuous 1/8" x 1" steel top & lock side "tamper guard"
- Tamper proof hinges
- 24 Ga. perforated steel mesh for extra security

Specify left or right side hinges (from outside looking in)

- Contrasting color mesh is an upgrade for an additional charge
- Precision SAFEGUARD packaging - complete with one-way mounting screws

Stocked Finishes

- Black with matching powder coated perforated steel mesh

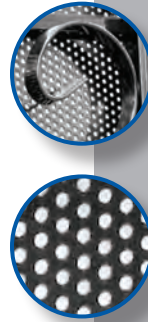

Heavy Duty



Features

- Standard sizes:
2'6" x 6'8" (33" x 81-3/4" Net overall frame)
2'8" x 6'8" (35" x 81-3/4" Net overall frame)
3'0" x 6'8" (39" x 81-3/4" Net overall frame)
- Custom sizes available
- 1-1/4" sq. x 18 Ga. 3-piece steel mounting frame
- 1" x 2" x 16 Ga. steel door frame
- 5/8" sq. x 18 Ga. crescent picket at lock-box
- 1/2" sq. x 18 Ga. radiant pickets
- Double hole lock-box w/ 2-1/8" bore & 2-3/8" backset
- Continuous 1/8" x 3/4" lock side "tamper guard"
- Tamper proof hinges
- 24 Ga. perforated steel mesh for extra security
- Non-handed
- Contrasting color mesh (as shown) is an upgrade for an additional charge
- Precision SAFEGUARD packaging - complete with one-way mounting screws

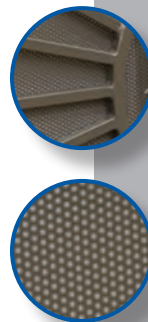

Stocked Finishes

- Adobe, almond, black, bronze or white with matching powder coated perforated steel mesh



Features

- Standard sizes:
 - 2'6" x 6'8" (33" x 81-3/4" Net overall frame)
 - 2'8" x 6'8" (35" x 81-3/4" Net overall frame)
 - 3'0" x 6'8" (39" x 81-3/4" Net overall frame)
- Custom sizes available
- 1-1/4" sq. x 18 Ga. 3-piece steel mounting frame
- 1" sq. x 18 Ga. steel door frame
- 5/8" sq. x 18 Ga. vertical steel pickets
- 1/2" sq. x 18 Ga. horizontal steel pickets
- Double hole lock-box w/ 2-1/8" bore & 2-3/8" backset
- Continuous 1/8" x 3/4" lock side "tamper guard"
- Tamper proof hinges
- 24 Ga. perforated steel mesh for extra security
- Non-handed
- Contrasting color mesh (as shown) is an upgrade for an additional charge
- Precision SAFEGUARD packaging - complete with one-way mounting screws

Stocked Finishes

- Adobe, almond, black, bronze, or white with matching powder coated perforated steel mesh

CAROLINA (Series 3811)



Features

- Standard sizes:
 - 2'6" x 6'8" (33" x 81-3/4" Net overall frame)
 - 2'8" x 6'8" (35" x 81-3/4" Net overall frame)
 - 3'0" x 6'8" (39" x 81-3/4" Net overall frame)
- Custom sizes available
- 1-1/4" sq. x 18 Ga. 3-piece steel mounting frame
- 1" x 2" x 16 Ga. steel door frame
- 5/8" sq. x 18 Ga. vertical steel pickets
- 1/2" sq. x 18 Ga. horizontal steel pickets
- Double hole lock-box w/ 2-1/8" bore & 2-3/8" backset
- Continuous 1/8" x 3/4" lock side "tamper guard"
- Tamper proof hinges
- 24 Ga. perforated steel mesh for extra security
- Non-handed
- Contrasting color mesh (as shown) is an upgrade for an additional charge
- Precision SAFEGUARD packaging - complete with one-way mounting screws

Stocked Finishes

- White with matching powder coated perforated steel mesh

STEEL SECURITY DOORS

Custom options (add-ons) for domestic steel security doors

Product Line Z9999 for all options on this page

Option	Option Code	Description
Mounting Variations (Refer to Page 49)	OP-SurfaceMt	Surface mount (standard)
	OP-InsetMt	Inset mount
	OP-InstMtTab	Inset mount w/tabs (specify tab size)
	OP-SurfMtTab	Surface mount w/tabs (specify tab size)
	OP-SMStndOffTab	Surface mount w/stand-off tabs (specify tab size)
	OP-SMTubeBack	Surface mount w/tube backing
	OP-IMFullStrap	Inset mount w/full strapping (specify strapping width)
	OP-IMSurfTab	Inset mount w/surface tabs (specify tab size)
Frame Variations	OP-3Piece	Three piece - door w/hinge bar, header bar, & strike bar (standard)
	OP-1Pc3Side1.25	One piece 3-sided 1-1/4" pre-hung frame
	OP-1Pc3Side1.5	One piece 3-sided 1-1/2" pre-hung frame
	OP-1Pc4Side1.25	One piece 4-sided 1-1/4" pre-hung frame
	OP-1Pc4Side1.5	One piece 4-sided 1-1/2" pre-hung frame
Double Door		Set-up (price of two custom doors and add:)
	OP-DDCaneBolts	Double door w/cane-bolts (standard)
	OP-DDFlushBolts	Double door w/flush extension bolts in door stile
Lock-Box	OP-INSTL8560	Single hole lock-box
	OP-RingGuard	Ring guard - welded
	OP-HandlePull	Handle pull
	OP-SpecLBLoc	Special lock-box location
Door Coverings	OP-24GaPerf	24 Ga. perforated steel mesh w/ 3/32" dia holes (standard)
	OP-ContPerf	Contrasting color perforated mesh
	OP-16GaExpnd	16 Ga. 1/2" expanded metal screen
	OP-13GaExpnd	13 Ga. 1/2" expanded metal screen
	OP-24GaSolid	24 Ga. solid sheet metal
	OP-HexPerfScreen-16	16 Ga. hexagon perforated steel mesh w/ screen
	OP-HexPerfScreen-22	22 Ga. hexagon perforated steel mesh w/ screen
	OP-NoPerf	No covering
Mail Slots	OP-MailSlitNoCvr	Cut-out, no cover (12" x 3" I.D.)
	OP-MailSlitWCvr	Cut-out, with cover (12" x 3" I.D.)
Pet Door Cut-Outs	OP-PD-CUTOUT-S	Cut-out for small pet door
	OP-PD-CUTOUT-M	Cut-out for medium pet door
	OP-PD-CUTOUT-L	Cut-out for large pet door
	OP-PD-CUTOUT-X	Cut-out for extra-large pet door
Pet Door Installed	OP-PD-STL-S	Cut-out and install small pet door
	OP-PD-STL-M	Cut-out and install medium pet door
	OP-PD-STL-L	Cut-out and install large pet door
	OP-PD-STL-X	Cut-out and install extra large pet door
Transoms (Up to 24" High)	OP-Trnsm-NoPerf	To doors with no perforated steel mesh
	OP-Trnsm-Perf	To doors with perforated steel mesh
	OP-Trnsm-Perf	To doors with expanded metal mesh
	OP-ArchedTop	Arched doors one piece pre-hung frame only - specify handing, provide template
Hydraulic Closer	OP-HydraulicClr	Hydraulic closer (not installed); mounting plates welded to frame & door
Primer	OP-Primerpaint	Primer undercoat + paint for extra rust protection

See price list for additional "OP" options

SECURITY DOOR ACCESSORIES



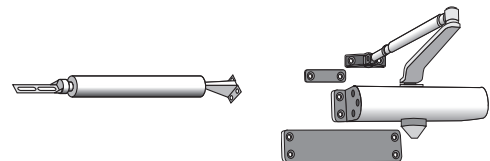









Option	Product Line	Description
2126BZ	F3970	Standard door closer, bronze
2126BK	F3970	Standard door closer, black
2127BK	G8002	Heavy duty closer, black
213007	G8002	Hydraulic door closer w/plates, gray only











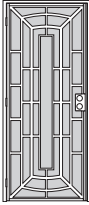

REMOVABLE INSERT DESIGNS

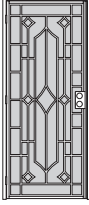
For Vineyard, Paradise, Impressions & Longevity doors



Standard colors: Adobe, almond, black, bronze or white

Product Line	Description	Option Code	Product Line	Description	Option Code		
	G8805	Cactus	OP-Cactus		G8805	Humming bird <i>Included standard with Paradise doors</i>	OP-Hummingbird
	G8805	Coyote	OP-Coyote		G8805	Longevity <i>Included standard with Longevity doors</i>	OP-Longevity
	G8805	Deer scene	OP-DeerScene		G8805	Love birds	OP-Lovebirds
	G8805	Dolphins	OP-Dolphin		G8805	Palm tree	OP-PalmTree
	G8805	Gecko	OP-Gecko		G8805	Welcome <i>Included standard with Impressions & Vineyard doors</i>	OP-Welcome
	G8805	Horse	OP-Horse		G8805	Whale tail	OP-Whaletail

DOMESTIC STEEL SECURITY DOORS Standard size security doors

Name/ Series	Product Line	Description	Name/ Series	Product Line	Description
Paradise 3808 Page 25	G3012	 <p>Available in 2'6", 2'8" & 3'0" x 6'8" Custom sizes available 1-1/4" sq. x 18 Ga. 3-piece mounting frame 1" sq. x 18 Ga. steel door frame Welded on "hummingbird" insert 24 Ga. perf. steel mesh for extra security Stocked colors: Almond or white with matching powder coated perforated steel mesh</p>	San Marino 3840 Page 28 NEW!	G3012	 <p>This door series is built to order 1-1/4" sq. x 18 Ga. 3-piece mounting frame 1" sq. x 18 Ga. steel door frame "San Marino" design, water jet cut from 1/8" steel</p>
Longevity 3834 Page 25	G3007	 <p>This door series is built to order 1-1/4" sq. x 18 Ga. pre-hung mounting frame 1" x 2" x 16 Ga. steel door frame Removable "longevity" insert 24 Ga. perf. steel mesh for extra security</p>	Deco 3842 Page 28 NEW!	G3012	 <p>This door series is built to order 1-1/4" sq. x 18 Ga. 3-piece mounting frame 1" sq. x 18 Ga. steel door frame "Deco" design, water jet cut from 1/8" steel</p>
Vineyard 3823 Page 26	G3007	 <p>This door series is built to order 1-1/4" sq. x 18 Ga. 3-piece mounting frame 1" sq. x 18 Ga. steel door frame "Vineyard" design, water jet cut from 1/8" steel Removable "welcome" insert</p>	Franciscan 3815 Page 29 NEW!	G3007	 <p>This door series is built to order 1-1/4" sq. x 18 Ga. 3-piece mounting frame 1" sq. x 18 Ga. steel door frame 24 Ga. perf. steel mesh for extra security</p>
Vineyard Full 3826 Page 26 NEW!	G3012	 <p>This door series is built to order 1-1/4" sq. x 18 Ga. 3-piece mounting frame 1" sq. x 18 Ga. steel door frame "Vineyard full" design, water jet cut from 1/8" steel</p>	Italian Leaf 3824 Page 29 NEW!	G3007	 <p>This door series is built to order 1-1/2" sq. x 16 Ga. one-piece mounting frame 1" sq. x 18 Ga. steel door frame 24 Ga. perf. steel mesh for extra security</p>
Impressions 3822 Page 27	G3007	 <p>This door series is built to order 1-1/4" sq. x 18 Ga. 3-piece mounting frame 1" sq. x 18 Ga. steel door frame Removable "welcome" insert 24 Ga. perf. steel mesh for extra security</p>	English Ivy 3829 Page 30 NEW!	G3007	 <p>This door series is built to order 1-1/2" sq. x 16 Ga. one-piece mounting frame 1" sq. x 18 Ga. steel door frame 24 Ga. perf. steel mesh for extra security</p>
Southwest 3837 Page 27 NEW!	G3012	 <p>This door series is built to order 1-1/4" sq. x 18 Ga. 3-piece mounting frame 1" sq. x 18 Ga. steel door frame "Southwest" design, water jet cut from 1/8" steel</p>	Sonoma 3830 Page 30 NEW!	G3007	 <p>This door series is built to order 1-1/2" sq. x 16 Ga. one-piece mounting frame 1" sq. x 18 Ga. steel door frame 24 Ga. perf. steel mesh for extra security</p>

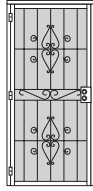
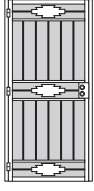
DOMESTIC STEEL SECURITY DOORS Standard size security doors

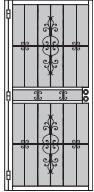
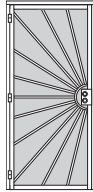
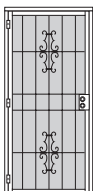
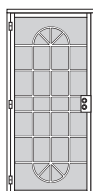
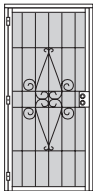
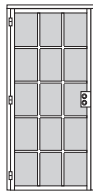
Name/ Series	Product Line	Description	Name/ Series	Product Line	Description
Woodguard 3809 Page 31	G3007	 <p>Available in 2'6", 2'8" & 3'0" x 6'8" Custom sizes available 1-1/4" sq. x 18 Ga. 3-piece mounting frame 1" sq. x 18 Ga. steel door frame 3/4" Thick colonial wood pattern 24 Ga. perf. steel mesh for extra security Stocked colors: Frame only: Almond, black, bronze or white Wood insert is only available in oak stain</p>	Madrid 3806 Page 33	G3012	 <p>Available in 2'6", 2'8" & 3'0" x 6'8" Custom sizes available 1-1/4" sq. x 18 Ga. 3-piece mounting frame 1" sq. x 18 Ga. steel door frame 1/8" Thick x 1/2" wide steel scroll designs 24 Ga. perf. steel mesh for extra security Stocked colors: Black or white with matching powder coated perforated steel mesh</p>
Dakota 3814 Page 31	G3007	 <p>Available in 2'6", 2'8" & 3'0" x 6'8" Custom sizes available 1-1/4" sq. x 18 Ga. 3-piece mounting frame 1" x 2" x 16 Ga. steel door frame 11 Ga. Dakota designs at top, center, & bottom 24 Ga. perf. steel mesh for extra security Stocked colors: Adobe or almond with matching powder coated perforated steel mesh</p>	Steel Master 3812 Page 34	G3007	 <p>Available in 2'6", 2'8" & 3'0" x 6'8" Custom sizes available 1-1/2" sq. x 16 Ga. one piece - 3 sided frame 1" sq. x 16 Ga. steel door frame 1/8" Thick x 1/2" wide steel scroll designs 24 Ga. perf. steel mesh for extra security Stocked colors: Black with matching powder coated perforated steel mesh</p>
Imperial 3831 Page 32	G3009	 <p>Available in 2'6", 2'8" & 3'0" x 6'8" Custom sizes available 1-1/4" sq. x 18 Ga. 3-piece mounting frame 1" sq. x 18 Ga. steel door frame Ten signature aluminum castings 24 Ga. perf. steel mesh for extra security Stocked colors: Black or white with matching powder coated perforated steel mesh</p>	Sunburst 3841 Page 34	G3007	 <p>Available in 2'6", 2'8" & 3'0" x 6'8" Custom sizes available 1-1/4" sq. x 18 Ga. 3-piece mounting frame 1" x 2" x 16 Ga. steel door frame 1/2" sq. x 18 Ga. radiant pickets 24 Ga. perf. steel mesh for extra security Stocked colors: Adobe, almond, black, bronze or white with matching powder coated perforated steel mesh</p>
Granada 3803 Page 32	G3007	 <p>Available in 2'6", 2'8" & 3'0" x 6'8" Custom sizes available 1-1/4" sq. x 18 Ga. 3-piece mounting frame 1" sq. x 18 Ga. steel door frame Two signature aluminum castings 24 Ga. perf. steel mesh for extra security Stocked colors: Adobe, almond, black, bronze or white with matching powder coated perforated steel mesh</p>	Clarion 3821 Page 35	G3007	 <p>Available in 2'6", 2'8" & 3'0" x 6'8" Custom sizes available 1-1/4" sq. x 18 Ga. 3-piece mounting frame 1" sq. x 18 Ga. steel door frame 24 Ga. perf. steel mesh for extra security Stocked colors: Adobe, almond, black, bronze or white with matching powder coated perforated steel mesh</p>
Barcelona 3804 Page 33	G3007	 <p>Available in 2'6", 2'8" & 3'0" x 6'8" Custom sizes available 1-1/4" sq. x 18 Ga. 3-piece mounting frame 1" sq. x 18 Ga. steel door frame 1/8" Thick x 1/2" wide steel scroll design 24 Ga. perf. steel mesh for extra security Stocked colors: Black, bronze or white with matching powder coated perforated steel mesh</p>	Carolina 3811 Page 35	G3007	 <p>Available in 2'6", 2'8" & 3'0" x 6'8" Custom sizes available 1-1/4" sq. x 18 Ga. 3-piece mounting frame 1" x 2" x 18 Ga. steel door frame 24 Ga. perf. steel mesh for extra security Stocked colors: White with matching powder coated perforated steel mesh</p>

DOUBLE DOOR, PATIO DOOR & PORCH ENCLOSURES

CENTURION

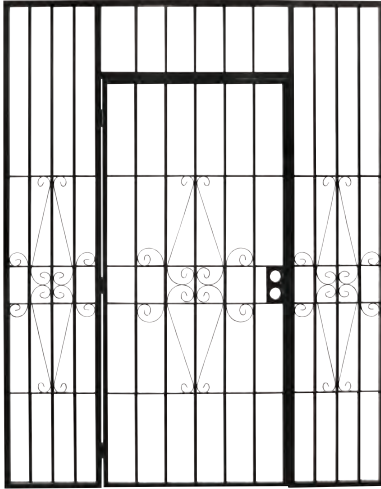

Porch

KNIGHTGUARD

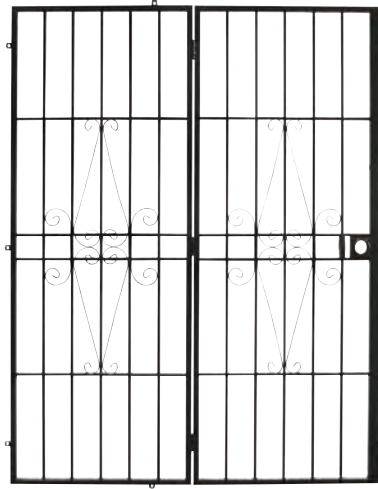

Double

SENTINEL



Patio

Most single door patterns can be ordered on the above systems. Refer to each page for limitations.

Example: Franciscan double door





Features

- Custom built to order
- 1-1/4" sq. x 16 Ga. one piece frame
- 1 ea. 3'0" x 6'8" Standard door
- 1" sq. x 16 Ga. steel door frame
- 5/8" sq. x 18 Ga. vertical steel pickets
- 3/8" sq. x 18 Ga. horizontal steel pickets
- 1/8" Thick x 1/2" wide steel scroll designs
- Double hole lock-box w/ 2-1/8" bore & 2-3/8" backset
- Continuous 1/8" x 1" "tamper guard" on lock side & top
- Tamper proof hinges
- Optional 24 Ga. perforated steel mesh for extra security is available as an upgrade for an additional charge

- **Must specify handing**

Stocked Finishes

- Built to order

***Cannot make in Deco, San Marino, or any other water jet cut patterns on this system**

KNIGHTGUARD HINGED PATIO DOOR (Series 3902)

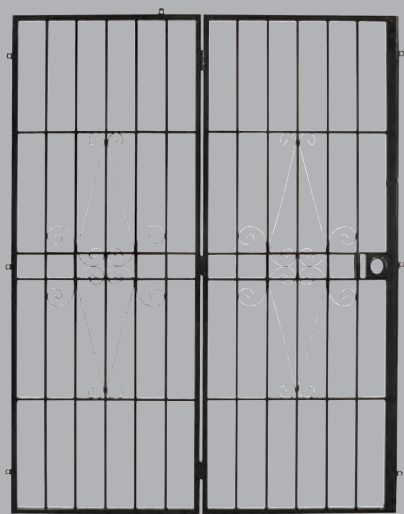

Features

- Standard sizes
 - 5'0" x 6'8" (61-1/2" x 80" Net overall frame)
 - 6'0" x 6'8" (73-1/2" x 80" Net overall frame)
 - 8'0" x 6'8" (97-1/2" x 80" Net overall frame)
- Custom sizes available
- 1" sq. x 18 Ga. frame
- 1/2" sq. x 18 Ga. vertical steel pickets
- 1/2" sq. x 18 Ga. horizontal steel pickets
- 1/8" Thick x 1/2" wide steel scroll designs
- Single hole lock-box w/ 2-1/8" bore & 2-3/8" backset
- Continuous 1/8" x 3/4" lock side "tamper guard"
- Tamper proof hinges
- 16 Ga. expanded metal (1/2") on active door (standard)
- Optional 24 Ga. perforated steel mesh for extra security is available as an upgrade for an additional charge
- Non-handed
- Hinged at center
- 1" Stand-off tab standard

Stocked Finishes

- Black powder coat

***Cannot make in Deco, San Marino, or any other water jet cut patterns on this system**

Features

- Standard sizes
5'0" x 6'8" (61-1/2" x 82-1/2" Net overall frame)
6'0" x 6'8" (73-1/2" x 82-1/2" Net overall frame)
8'0" x 6'8" (97-1/2" x 82-1/2" Net overall frame)
- Custom sizes available
- 1" x 3" x 16 Ga. door jambs
- 1" sq. x 16 Ga. panel frames
- 5/8" sq. x 18 Ga. vertical steel pickets
- 3/8" sq. x 18 Ga. horizontal steel pickets
- 1/8" Thick x 1/2" wide steel scroll designs
- 2" x 2" x 1/8" Bottom sliding angle track
- 2 Point anti-lift system
- Overhead track w/plastic end caps
- Single cylinder hook lock w/lock guard
- Inside & outside handle pulls
- Surface mounted - 1" tabs
- 16 Ga. expanded metal (1/2") on active door (standard)
- Optional 24 Ga. perforated steel mesh for extra security is available as an upgrade for an additional charge

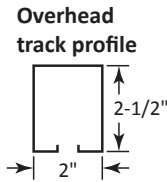

- **Specify left or right active door**

Stocked Finishes

- Built to order
- Knock down (K.D.) kit available
- *Cannot make in Southwest, Sunburst, or any water jet cut patterns on this system
- *Inset mounting tab not available

Features

- Custom built to order
- **1-1/2" sq. x 14 Ga. one piece frame**
- 1" sq. x 16 Ga. steel door frame
- 5/8" sq. x 18 Ga. vertical steel pickets
- 3/8" sq. x 18 Ga. horizontal steel pickets
- 1/8" Thick x 1/2" wide steel scroll design
- Single hole lock-box w/ 2-1/8" bore & 2-3/8" backset
- **Lock ring guard**
- Continuous 1/8" x 1" "tamper guard" on strike, top, & frame
- Tamper proof hinges
- 16 Ga. expanded metal (1/2") on active door (as shown) is standard
- Optional 24 Ga. perforated steel mesh for extra security is available as an upgrade for an additional charge

- **Specify left or right side active door**

- 1-1/2" Stand-off tabs standard
- Hinged at center

Stocked Finishes

- Built to order

Heavy Duty



STEEL PATIO DOORS & ENCLOSURES

Custom options (add-ons)

Product Line Z9999 for all options on this page

Option	Option Code	Description
Mounting Variations (Refer to Page 49)	OP-SurfaceMt	Surface mount (standard)
	OP-PDStndOffTab	Surface mount w/stand-off tabs (specify tab size)
	OP-PDSOTwStrap	Surface mount w/stand-off tabs & protective strap on lock side (specify tab size)
Lock-Box	OP-INSTL8560	Single hole lock-box
	OP-INSTL8559	Double hole lock-box
	OP-RingGuard	Ring guard - welded
	OP-HandlePull	Handle pull
	OP-SpecLBLoc	Special lock-box location
Door Coverings	OP-CONTPERFDD	Contrasting mesh option
	OP-24GaPerf2SD	24 Ga. perforated steel mesh w/ 3/32" dia holes (both sides)
	OP-16GaExpnd2SD	16 Ga. 1/2" expanded metal screen (both sides)
	OP-13GaExpnd2SD	13 Ga. 1/2" expanded metal screen (both sides)
	OP-24GaSolid2SD	24 Ga. solid sheet metal (both sides)
Door designs	OP-PDCarolina	Carolina style
	OP-PDDakota	Dakota style
	OP-PDGranada	Granada style
	OP-PDParadise	Paradise style (select insert)
	OP-PDImpression	Impressions style (select insert)
	OP-PDImperial	Imperial style
	OP-PDWoodguard	Woodguard style
	OP-PDClarion	Clarion style
	OP-PDSunburst	Sunburst style
	OP-PDLongevity	Longevity style (select insert)
	OP-PD Sonoma	Sonoma style
	OP-PDEnglishIvy	English Ivy style
	OP-PDItalianLeaf	Italian Leaf style
OP-PDFranciscan	Franciscan style	
Centurion Enclosure	OP-INSTL8560	Single hole lock-box
	OP-PDCUTOUT	Cut-out (buttresses)
	OP-PDSPCLDOOR	Special size door to 45" x 85-1/2"
Sentinel	OP-FULLFRMSENT	Full frame sentinel (specify handing)
Steelmaster	OP-BOTHACTIVE	Both doors operable
Primer	OP-Primerpaint	Primer undercoat + paint for extra rust protection

STEEL PATIO DOORS & ENCLOSURES

3901 Centurion Enclosure with Door Product Line: G3015

Features

- 1-1/4" sq. x 16 Ga. one piece frame
- 1 ea. 3'0" x 6'8" standard door
- 1" sq. x 16 Ga. steel door frame
- 5/8" sq. x 18 Ga. vertical steel pickets
- 3/8" sq. x 18 Ga. horizontal steel pickets
- 1/8" Thick x 1/2" wide steel scroll designs
- Double hole lock-box w/ 2-1/8" bore & 2-3/8" backset
- Continuous 1/8" x 1" "tamper guard" on lock side & top
- Tamper proof hinges
- Optional 24 Ga. perforated steel mesh for extra security is available as an upgrade for an additional charge
- **Specify handing** (refer to page 48)

Stocked Finishes

- Built to order

Note: Perforated or expanded metal is optional.
See page 43 for custom options.

***Cannot make in Deco, San Marino, or any other water jet cut patterns on this system**

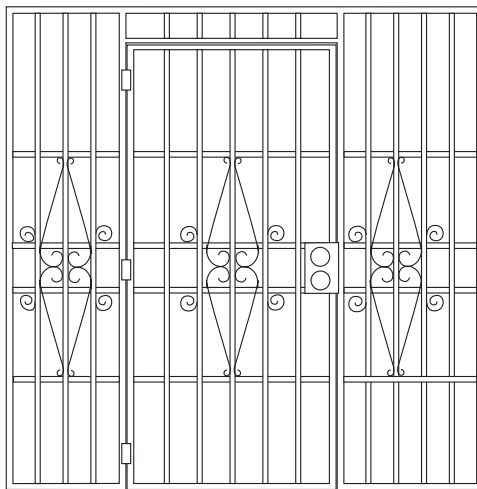

Up to: 7'0" x 8'0" 84" x 96"	Up to: 9'0" x 8'6" 108" x 100"	Up to: 11'0" x 8'6" 132" x 100"	Up to: 13'0" x 8'6" 156" x 100"	Up to: 15'0" x 9'0" 180" x 108"
------------------------------------	--------------------------------------	---------------------------------------	---------------------------------------	---------------------------------------

All Centurion Enclosures are Built to Order
Call for quote on any size or options not shown

3902 Knightguard Hinged Patio Door Product Line: G3015

Features

- 1" sq. x 18 Ga. frame
- 1/2" sq. x 18 Ga. vertical steel pickets
- 1/2" sq. x 18 Ga. horizontal steel pickets
- 1/8" Thick x 1/2" wide steel scroll designs
- Single hole lock-box w/ 2-1/8" bore & 2-3/8" backset
- Continuous 1/8" x 3/4" lock side "tamper guard"
- Tamper proof hinges
- 16 Ga. expanded metal (1/2") on active door (standard)
- Non-handed
- Hinged at center
- 1" Stand-off tabs
- Optional 24 Ga. perforated steel mesh for extra security is available as an upgrade for an additional charge

Stocked Finishes

- Black powder coat

See page 43 for custom options.

***4 Sided frame not available**

***Cannot make in Deco, San Marino, or any other water jet cut patterns on this system**

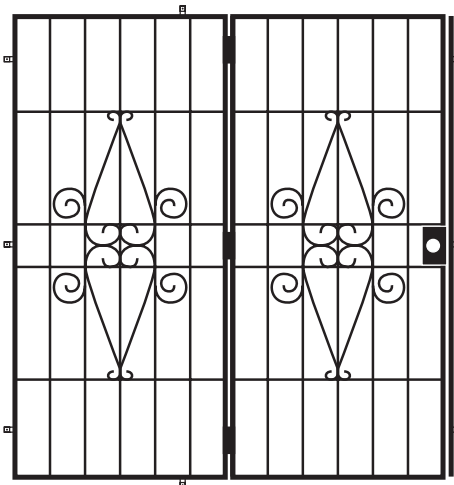

Up to: 5'0" x 6'8" 61-1/2" x 80"	Up to: 6'0" x 6'8" 73-1/2" x 80"	Up to: 8'0" x 6'8" 97-1/2" x 80"	Up to: 8'0" x 8'0" 97-1/2" x 96"	Up to: 10'0" x 8'0" 121-1/2" x 96"
--	--	--	--	--

Call for quote on any size or options not shown

STEEL PATIO DOORS & ENCLOSURES

3903 Sentinel Sliding Patio Door Product Line: G3015

Features

- 1" x 3" x 16 Ga. door jambs
- 1" sq. x 16 Ga. panel frames
- 5/8" sq. x 18 Ga. vertical steel pickets
- 3/8" sq. x 18 Ga. horizontal steel pickets
- 1/8" Thick x 1/2" wide steel scroll designs
- 2" x 2" x 1/8" Bottom sliding angle track
- Overhead track w/plastic end caps
- Single cylinder hook lock w/lock guard
- Inside & outside handle pulls
- Surface mounted - 1" tabs
- 16 Ga. expanded metal (1/2") on active door (standard)
- Optional 24 Ga. perforated steel mesh for extra security is available as an upgrade for an additional charge
- **Specify left or right active door**
- Knock down (K.D.) kit available

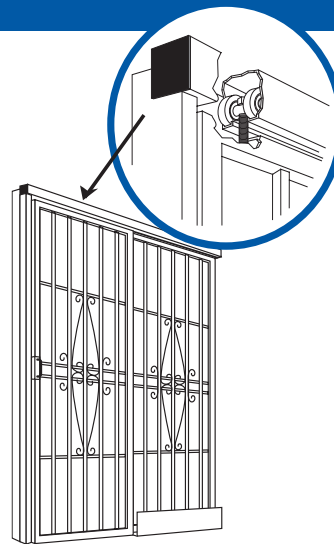

Stocked Finishes

- Built to order

See page 43 for custom options.

***Cannot make in Southwest, Sunburst, or any water jet cut patterns on this system**

Up to: 5'0" x 6'8" 61-1/2" x 82-1/2"	Up to: 6'0" x 6'8" 73-1/2" x 82-1/2"	Up to: 8'0" x 6'8" 97-1/2" x 82-1/2"	Up to: 8'0" x 8'0" 97-1/2" x 98-1/2"	Up to: 10'0" x 8'0" 121-1/2" x 98-1/2"
--	--	--	--	--

Call for quote on any size or options not shown

3904 Steelmaster (Full Frame) Product Line: G3015

Features

- 1-1/2" sq. x 14 Ga. one piece frame
- 1" sq. x 16 Ga. steel door frame
- 5/8" sq. x 18 Ga. vertical steel pickets
- 3/8" sq. x 18 Ga. horizontal steel pickets
- 1/8" Thick x 1/2" wide steel scroll design
- Single hole lock-box w/ 2-1/8" bore & 2-3/8" backset
- Lock ring guard
- Continuous 1/8" x 1" "tamper guard" on strike, top, & frame
- Tamper proof hinges
- 16 Ga. expanded metal (1/2") on active door (standard)
- Optional 24 Ga. perforated steel mesh for extra security is available as an upgrade for an additional charge
- 4 Sided frame available
- **Specify left or right side active door**
- 1-1/2" Stand-off tabs standard
- Hinged at center

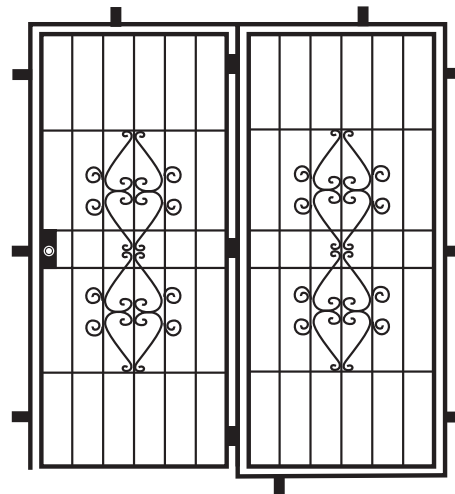

Stocked Finishes

- Built to order

See page 43 for custom options.

Up to: 5'0" x 6'8" 61-1/2" x 82"	Up to: 6'0" x 6'8" 73-1/2" x 82"	Up to: 8'0" x 6'8" 97-1/2" x 82"	Up to: 8'0" x 8'0" 97-1/2" x 98"	Up to: 10'0" x 8'0" 121-1/2" x 98"
--	--	--	--	--

Call for quote on any size or options not shown

WINDOW GUARDS

*When installing window guards ALWAYS conform to local building codes.
Precision will not assume liability pertaining to window guard usage/installation.



Note: always measure width x height in ft.- in.

Series No.	Description
450	1/2" sq. Tubular pickets (4" extension) 5/8" sq. Horizontal bars Apache spear point top & bottom All mounting hardware sold separately Black powder coat in stock (except cross hatch)

Product Line:
G3810

Available stocked in black (BK) as shaded in blue below.
All other colors: Almond (AL), bronze (BZ), or white (WH) are only available as special order.

To order in a color other than black, replace the BK in the sample part numbers listed in the table below with the abbreviation of the desired color.

		Width								
		1'6"	2'0"	2'6"	3'0"	3'6"	4'0"	4'6"	5'0"	6'0"
Height	1'6"	450BK1616	450BK2016	450BK2616	450BK3016	450BK3616	450BK4016	450BK4616	450BK5016	450BK6016
	2'0"	450BK1620	450BK2020	450BK2620	450BK3020	450BK3620	450BK4020	450BK4620	450BK5020	450BK6020
	2'6"	450BK1626	450BK2026	450BK2626	450BK3026	450BK3626	450BK4026	450BK4626	450BK5026	450BK6026
	3'0"	450BK1630	450BK2030	450BK2630	450BK3030	450BK3630	450BK4030	450BK4630	450BK5030	450BK6030
	3'6"	450BK1636	450BK2036	450BK2636	450BK3036	450BK3636	450BK4036	450BK4636	450BK5036	450BK6036
	4'0"	450BK1640	450BK2040	450BK2640	450BK3040	450BK3640	450BK4040	450BK4640	450BK5040	450BK6040
	4'6"	450BK1646	450BK2046	450BK2646	450BK3046	450BK3646	450BK4046	450BK4646	450BK5046	450BK6046
	5'0"	450BK1650	450BK2050	450BK2650	450BK3050	450BK3650	450BK4050	450BK4650	450BK5050	450BK6050
6'0"	450BK1660	450BK2060	450BK2660	450BK3060	450BK3660	450BK4060	450BK4660	450BK5060	450BK6060	

For Series 450:

4'6" wide and larger window guards have additional top and bottom locations for center brackets and if used will require **2 additional brackets (part #8103-PK).**

4'6" high and larger window guards have additional horizontal cross bar and if used will require **2 additional brackets (part #8103-PK).**

Window guards beyond 5'0" wide have 2 horizontal scroll patterns. Window guards less than 2'0" in any dimension have modified scroll work.

Series No.	Description
460	5/8" sq. Tubular pickets (4" extension) 5/8" sq. Horizontal bars Apache spear point top & bottom All mounting hardware sold separately Special order for all sizes and colors

Product Line:
G3811



Note: always measure width x height in ft.- in.

Determine the correct part number to order using the following sample number: **460BK3036C**

460 = window guard series; **BK** = color (black); **30** = width in feet & inches (3'0"); **36** = height in feet & inches (3'6")

Available colors: Almond (AL), black (BK), bronze (BZ), or white (WH)

Standard widths: 1'6", 2'0", 2'6", 3'0", 3'6", 4'0", 4'6", 5'0", 6'0" & 8'0" | **Standard heights:** 1'6", 2'0", 2'6", 3'0", 3'6", 4'0", 4'6", 5'0" & 6'0"

For Series 460:

4'6" wide and larger window guards have additional top and bottom locations for center brackets and if used will require **2 additional brackets (part #8103-PK).**

4'6" high and larger window guards have additional horizontal cross bar and if used will require **2 additional brackets (part #8103-PK).**

Window guards beyond 5'0" wide have 2 horizontal scroll patterns. Window guards less than 2'0" in any dimension have modified scroll work.

Series No.	Description
455	1/2" sq. Solid steel pickets 5/8" sq. Horizontal bars Square cut ends top & bottom All mounting hardware sold separately Special order for all sizes and colors

Product Line:
G3812



Note: always measure width x height in ft.- in.

Determine the correct part number to order using the following sample number: **455BK3036C**

455 = window guard series; **BK** = color (black); **30** = width in feet & inches (3'0"); **36** = height in feet & inches (3'6")

Available colors: Almond (AL), black (BK), bronze (BZ), or white (WH)

Standard widths: 1'6", 2'0", 2'6", 3'0", 3'6", 4'0", 4'6", 5'0", 6'0" & 8'0" | **Standard heights:** 1'6", 2'0", 2'6", 3'0", 3'6", 4'0", 4'6", 5'0" & 6'0"

For Series 455:

4'6" wide and larger window guards have additional top and bottom locations for center brackets and if used will require **2 additional brackets (part #8103-PK).**

4'6" high and larger window guards have additional horizontal cross bar and if used will require **2 additional brackets (part #8103-PK).**

Window guards beyond 5'0" wide have 2 horizontal scroll patterns. Window guards less than 2'0" in any dimension have modified scroll work.

CUSTOM WINDOW GUARD APPLICATIONS

(Product Line: Z9999)

*When installing window guards ALWAYS conform to local building codes.
Precision will not assume liability pertaining to window guard usage/installation.

Add to the price of a standard (or custom size) window guard. Mounting brackets shown for clarity and are **not** included.

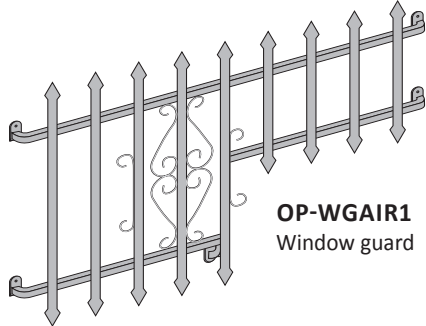

OP-WGAIR1
Window guard

AIR CONDITIONER CUT-OUT

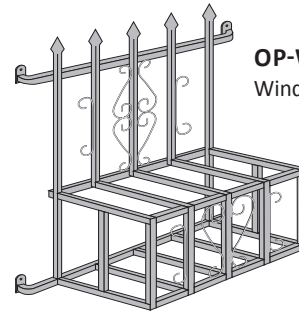

OP-WGAIR2
Window guard

AIR CONDITIONER CAGE

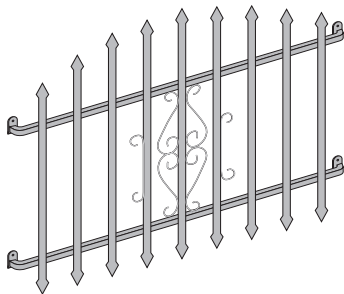

OP-WGPCKTS1
Window guard

ARCHED PICKETS

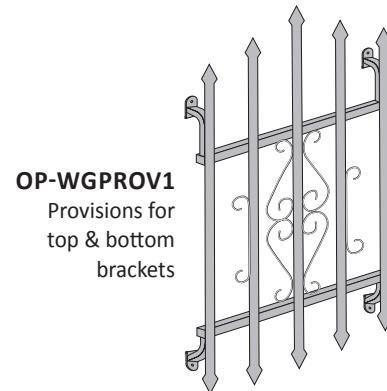

OP-WGPROV1
Provisions for
top & bottom
brackets

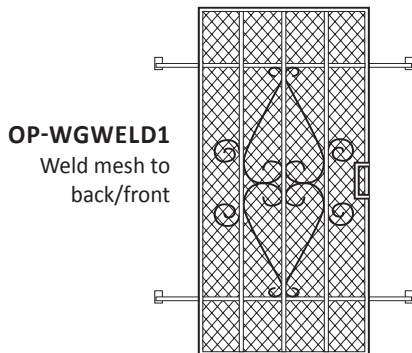

OP-WGWELD1
Weld mesh to
back/front

SECURITY MESH (Perforated or expanded)

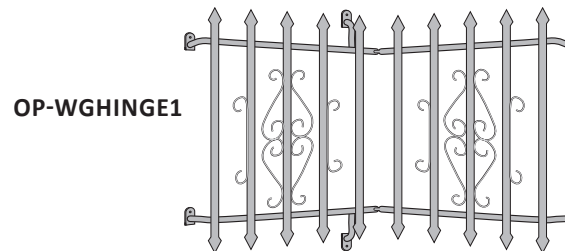

OP-WHINGE1

HINGED WINDOW GUARD

WINDOW GUARD ACCESSORIES

Part No.	Product Line	Description
----------	--------------	-------------

Window guard brackets		
<i>All brackets stocked in white and black. Adobe, almond and bronze are made to order</i>		
8100	G8100	3" Standard offset window guard bracket kit Pack consists of: 2 left hand, 2 right hand brackets and 4 each 5/16" x 3" one way lag screws.
8103	G8100	3" Standard center window guard bracket kit Pack consists of: 2 center brackets and 2 each 5/16" x 3" one way lag screws.
8106	G8100	Straight window guard bracket kit Pack consists of: 4 straight brackets and 4 each 5/16" x 3" one way lag screws.
8109	G8100	Flush window guard bracket kit Pack consists of: 2 left hand, 2 right hand flush brackets and 4 each 5/16" x 3" one way lag screws.
8111	G8100	Flush center - black (4 per) w/screws Pack consists of: 2 flush center guard brackets and 4 each 5/16" x 3" one way lag screws.
8113	G8100	1" Offset window guard bracket kit Pack consists of: 2 left hand and 2 right hand brackets and 4 each 5/16" x 3" one way lag screws.
8115	G8100	6" Offset window guard bracket kit Pack consists of: 2 left hand and 2 right hand brackets and 4 each 5/16" x 3" one way lag screws.
8116	G8100	Hinged center bracket Poly bag of 1 each; available in black.
8118	G8100	"T" bracket window guard kit Pack consists of: 2 "T" brackets and 2 each 5/16" x 3" one way lag screws.
8119	G8100	3" x 12" Offset window guard bracket kit

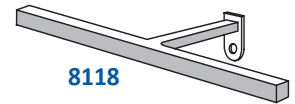
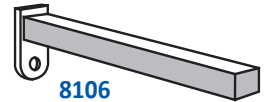

Hardware		
8117	G8100	Fire release hinge bracket kit Pack consists of: 1 fire release bracket and 1 each 5/16" x 3" one way lag screws; available in almond, black and white.
8124	G8100	Fire release shielded cable kit Order lag screws separately; available in black and white.

Part No.	Product Line	Pack QTY	Description
----------	--------------	----------	-------------

Tools			
8900	G8100	1	One way driving tool
8901	G8100	1	Adapter, used for 1/2" square drive

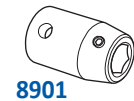
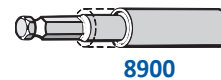

Fasteners			
<i>Available in adobe, almond, black, bronze and white</i>			
8130-2-4PK	G8100	4	5/16" x 2" lag screws
8130-3-4PK	G8100	4	5/16" x 3" lag screws
8130-4-4PK	G8100	4	5/16" x 4" lag screws
8130-2-100PK	G8100	100	5/16" x 2" lag screws
8130-3-100PK	G8100	100	5/16" x 3" lag screws
8130-4-100PK	G8100	100	5/16" x 4" lag screws

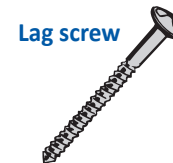

*Sample number for fasteners: **8130AD3-4PK** for a pack of 4 adobe colored 3" lag screws

SECURITY MESH GUARD

Part No.	Product Line	Description
DG30	G3813	23-1/4" x 43", Fits 30" door
DG32	G3813	25-1/4" x 43", Fits 32" door
DG36	G3813	29-1/4" x 43", Fits 36" door

Security mesh guard features:

- Strong 16 gauge expanded metal
- 1" angle - steel frame
- Black powder coat standard
- Complete with tabs and four 1" one-way screws

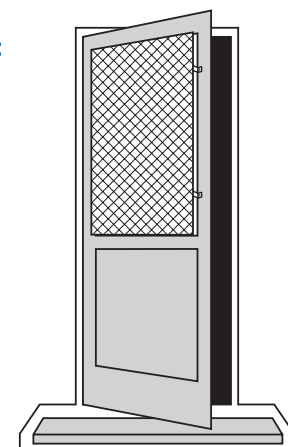

MESH GUARD OPTIONS

Part No.	Product Line	Description
DG11	—	Stand-off tabs - additional
DG100	G3813	1/2" Expanded metal (16 ga.)
DG200	G3813	Perforated metal (24 ga.)
DG300	G3813	Solid metal (24 ga.)

SECURITY DOOR MOUNTING VARIATIONS

SURFACE MOUNT

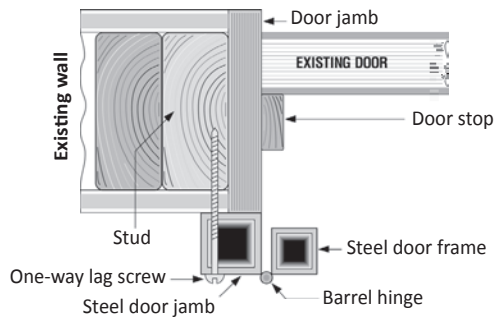

Surface mount standard

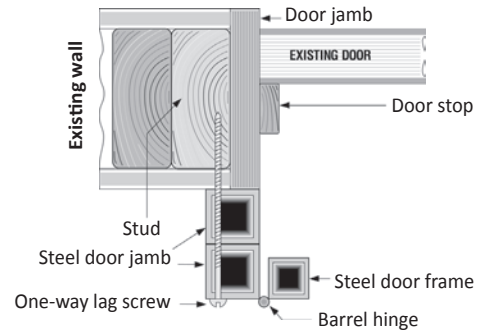

Surface mount w/tube backing

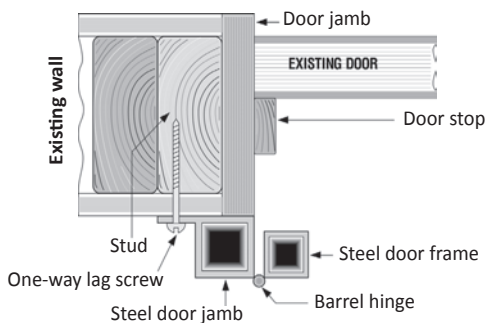

Surface mount w/tabs

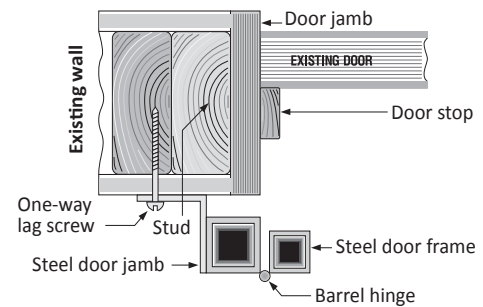

Surface mount w/stand-off tabs

INSET MOUNT

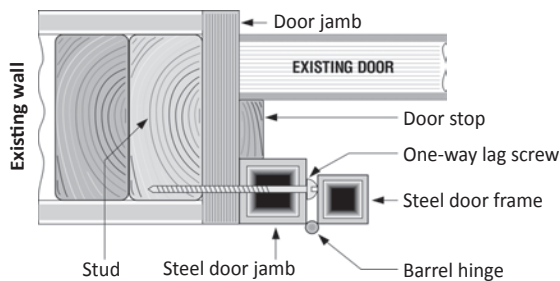

Inset mount

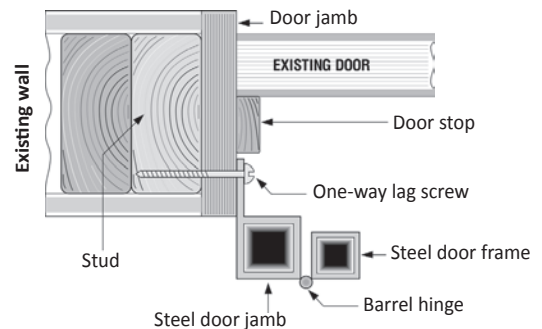

Inset mount w/tab

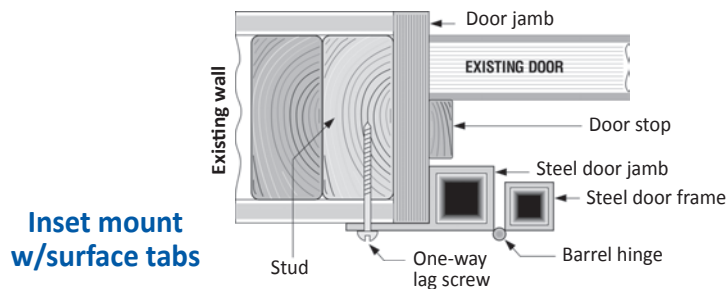

Inset mount w/surface tabs

Step 1: Determine Door Width

Measure the opening **"Width"** between the left and right **door jambs** as seen in **(Diagram A)**.

Record Opening **"Width"** Here: _____ "

(See page 4 of this worksheet for mounting options)

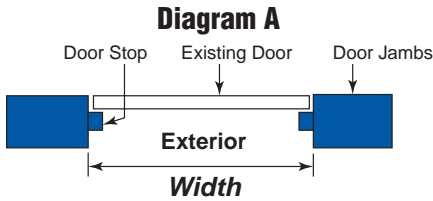

FOR SURFACE MOUNT

Then add 3" to arrive at the finished door width: _____ "

(Add 3-1/2" for Steel Master, English Ivy, Italian Leaf, & Sonoma Doors)

FOR INSET MOUNT

Then subtract 1/4" to arrive at the finished door width: _____ "

Step 2: Determine Door Height

Measure the opening **"Height"** from the bottom of door header to the top of the threshold as seen in **(Diagram B)**.

Record Opening **"Height"** Here: _____ "

Diagram B

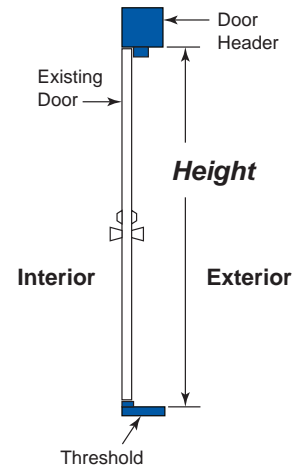

For a three (3) sided frame

FOR SURFACE MOUNT

Add 1-3/4" to arrive at the finished door height: _____ "
(Add 2" for Steel Master, English Ivy, Italian Leaf, & Sonoma Doors)

FOR INSET MOUNT

Subtract 1/4" to arrive at the finished door height: _____ "

For a four (4) sided frame

FOR SURFACE MOUNT

Add 3" to arrive at the finished door height: _____ "
(Add 3-1/2" for Steel Master, English Ivy, Italian Leaf, & Sonoma Doors)

FOR INSET MOUNT

Subtract 1/4" to arrive at the finished door height: _____ "

Step 3: Determine Hinge Side

Specify placement as either **"Left (or) Right Hand"** hinged as viewed from the **outside of the door** looking in as seen in **(Diagram C)**.

Left Hand Hinge **OR** Right Hand Hinge

Diagram C

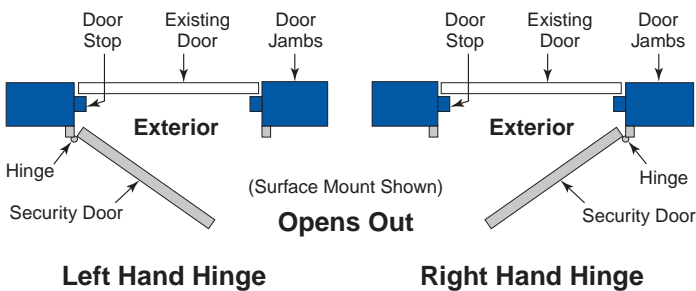

Step 4: Determine Lockbox Height

Measure from bottom of the door to center of the **"Lockbox"** as seen in **(Diagram D)**.

Record **"Lockbox"** Height Here: _____

Note: "Lockbox" will be "centered" if Lockbox height is "not" specified.

Diagram D

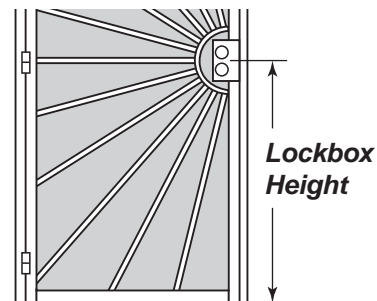

Step 5: Complete the following three (3) page order form and send it to our Precision customer service team.

Customer: _____

Door Model: _____

P.O.: _____ Date: _____

Door Size: Width: _____ Height: _____

Steel Security Doors:

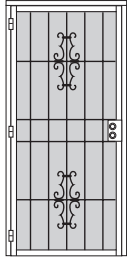

Granada

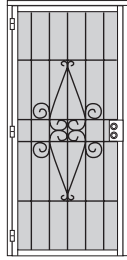

Barcelona

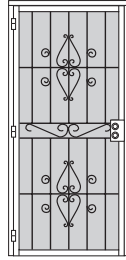

Madrid

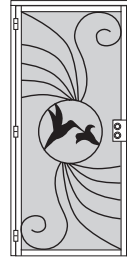

Paradise
(With Insert)

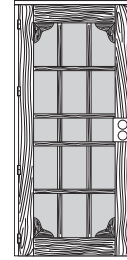

Woodguard

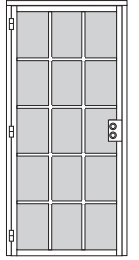

Carolina

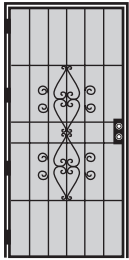

Steel Master

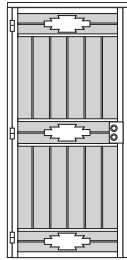

Dakota

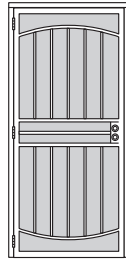

Franciscan

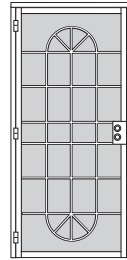

Clarion



Impressions
(With Insert)



Italian Leaf



English Ivy



Sonoma

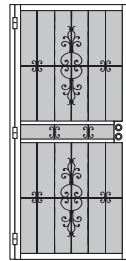

Imperial

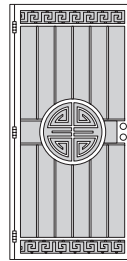

Longevity
(With Insert)

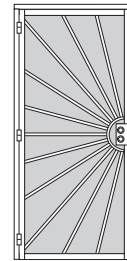

Sunburst

Water Jet Cut Door Designs:



Vineyard
(With Insert)



Full Vine

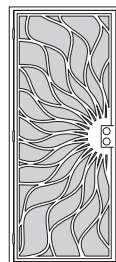

Southwest

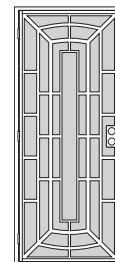

San Marino

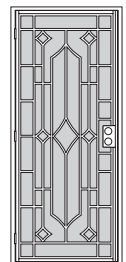

Deco

Color:

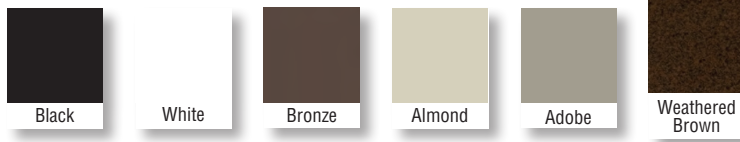

Door	<input type="checkbox"/>	<input type="checkbox"/>	<input type="checkbox"/>	<input type="checkbox"/>	<input type="checkbox"/>	<input type="checkbox"/>
Mesh	<input type="checkbox"/>	<input type="checkbox"/>	<input type="checkbox"/>	<input type="checkbox"/>	<input type="checkbox"/>	<input type="checkbox"/>

Primer:

Double Coat High Zinc Primer

Single Color Door
(Mesh to Match Door/Frame – Standard)

Contrasting Mesh (Two Tone)

Door Cover:

- 24 Ga. Perf (Standard)
- 1/2" Expanded (16 Ga.)
- Hex Perf with screen (22 Ga.)
- Hex Perf with screen (16 Ga.)
- Cloverleaf Perf with screen (22 Ga.)
- Grecian Perf with screen (22 Ga.)
- No Covering



Perforated

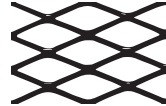

1/2" Expanded



Hex Perf



Cloverleaf Perf

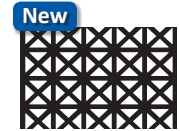

Grecian Perf

Hex Perf, Cloverleaf Perf and Grecian Perf door covers allow for high air flow and improved visibility.

Contrasting mesh is **not** available with **Hex Perf** door covers.

Handing: Single Door (Viewed from the outside looking in)

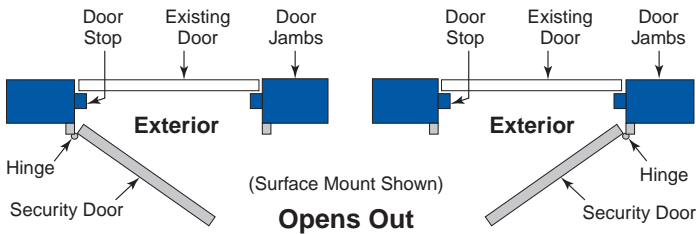

Left Hand Hinge

Left Hand Hinge

Right Hand Hinge

Right Hand Hinge

Active Door: Double Door (Viewed from the outside looking in)

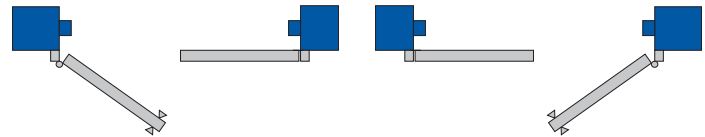

Left Door Active

Left Door Active

Right Door Active

Right Door Active

Cane Bolts

Flush Extension Bolts

Lock-Box:

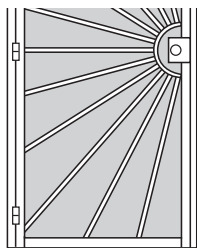

Single Hole

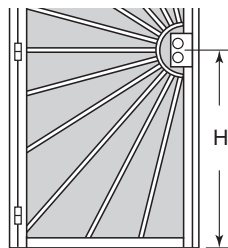

Double Hole

Double Hole (Standard)

Single Hole

Distance from Bottom of Door to Center of Lock-Box: _____
(Lock-Box at Center - Standard)

Frame:

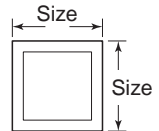

1-1/4" square (3) Piece (Standard)

1-1/4" square **One Piece** Welded Frame (3) Sided

1-1/4" square **One Piece** Welded Frame (4) Sided

1-1/2" square **One Piece** Welded Frame (3) Sided
(Standard on: Steel Master, English Ivy, Italian Leaf, & Sonoma)

1-1/2" square **One Piece** Welded Frame (4) Sided

Mounting:

- Surface (Standard)
- Inset
- Inset with Tabs
- Surface with Tabs
- Inset with Surface Tabs

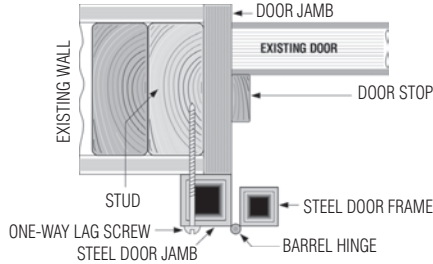

SURFACE MOUNT (STANDARD)

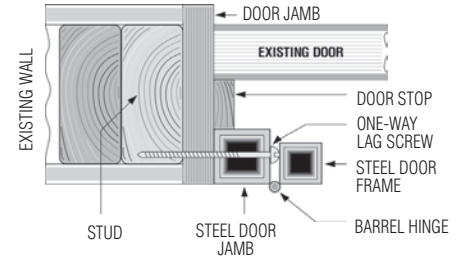

INSET MOUNT

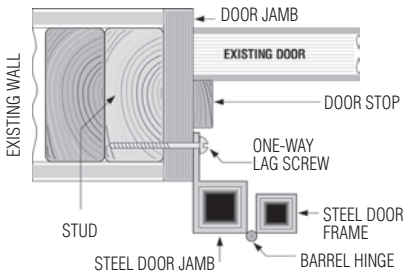

INSET MOUNT W/TAB

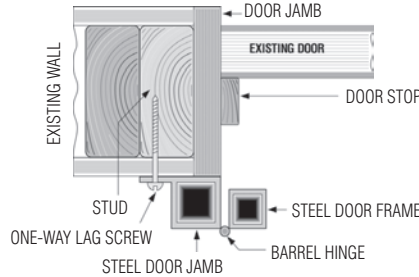

SURFACE MOUNT W/TABS

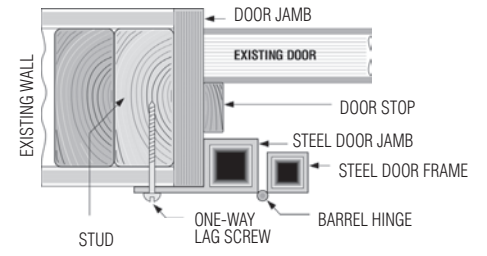

INSET MOUNT W/SURFACE TABS

Removable Center Insert Designs (See page 35): (For Our Impressions, Paradise, Longevity, & Vineyard Doors Only)



Cactus



Coyote



Deer scene



Dolphins



Gecko



Horse



Hummingbird



Longevity



Love birds



Palm tree



Welcome



Whale tail

***Ask about our custom design services**

PRECISION SCREEN & SECURITY PRODUCTS

PRO STEEL SECURITY DOOR WORKSHEET

Door Model: _____			Customer: _____		
Size: _____ Width x _____ Height			P.O.: _____		
Net Frame (Overall Width x Overall Height)			Date: _____		
Color:	Door	Mesh	Frame:	1-1/4" sq. (3) Piece (Std.)	
Black				1-1/4" sq. One Piece (3) Sided	
White				1-1/4" sq. One Piece (4) Sided	
Bronze				1-1/2" sq. (3) Piece	
Almond				1-1/2" sq. One Piece (3) Sided	
Adobe				1-1/2" sq. One Piece (4) Sided	
Weathered Brown			Mounting:	Surface Mount (Std.)	
Primer:	Double Coat			Inset Mount	
	High Zinc Primer			Inset Mount w/Tabs	
Door Cover:	24 Ga. Perf (Standard)			Inset Mount w/Offset Tabs	
	1/2" Expanded (16 Ga.)			Surface Mount w/Tabs	
	No Covering			Inset Mount w/Surface Tabs	
	Stainless Steel Mesh (Black Only)			Surface Mount w/Stand-off Tabs	
	Hex Perf w/Screen (22 Ga.)			Tab Length (1", 1-1/2", 2", 3")	
	Hex Perf w/Screen (16 Ga.)			Surface Mount Tube Backing	
	1/2" Expanded (13 Ga.)			Inset Mount w/Full Strapping	
	Solid Sheet (24 Ga.)			Strapping Width (1-1/2", 2", 3" 4")	
Handing:	Right Hand Hinge		Center Insert Designs:	Cactus	
Single Door	Left Hand Hinge			Coyote	
(Outside Looking In)	Opens Out		(Impressions)	Deer scene	
	Opens In		(Longevity)	Dolphins	
Active Door:	Right Door Active		(Paradise)	Gecko	
Double Door	Left Door Active		(Vineyard)	Horse	
(Outside Looking In)	Flush Extension Bolts			Hummingbird	
	Cane Bolts			Longevity	
	Flush Top - Cane Bottom			Love birds	
Lock-Box:	Double Hole (Standard)			Palm tree	
	Single Hole			Welcome	
	Ring Guard			Whale tail	
	Distance from Bottom of Door to Center of Lock-Box (Lock-Box at Center - Standard)		Plasma Cut Door Designs:	Vineyard w/Insert	
Special Instructions:				Full Vine	
				Southwest	
				San Marino	
				Deco	
			Mail Slot:	Mail Slot w/No Cover	
				Mail Slot w/Cover	
			Mail Slot Location:		

SECTION 3 / ECONOMY STEEL SECURITY DOORS

PRODUCT	PAGE
Economy steel security doors.....	56-60
Economy steel security door list.....	61

ECONOMY STEEL SECURITY DOORS

This section includes photographs and specifications of Precision’s line of economy steel security doors. Although these products are not manufactured at our Redlands, CA facility, all items are welded, assembled and finished using high quality raw materials and are designed and priced to allow your customers the option of purchasing a reasonable quality, reasonably priced door.

For applications where finish, special options and custom features are critical, please go to section 2 of this catalog where our Precision made to order domestic steel security doors are shown.

Our economy line of steel security doors have a 90 day limited warranty against functional manufacturing defects only. Cosmetic defects do affect the applications and uses for which this door is designed. Due to these doors being a lower cost option to our domestic line of steel security doors, we cannot accept any returns or credits for cosmetic issues.

Only the standard sizes and colors shown are available on the Precision economy line of steel security doors.

Standard “net” frame sizes

Standard “net” sizes shown indicate the typical “call-out” size plus the outside mounting frame. Please keep these dimensions in mind when ordering. If a standard sized door will not fit the opening measurements, please go to section 2, where “custom” sized product may be ordered.

Precision economy steel security doors come as **surface mount**.

The **standard sizes** indicated in this section represent “industry standard” door openings.

Economy steel security door dimensions for the Valdor, Regal, Regent & Orleans:

A. The net overall size, which includes the 3-piece mounting frame, is as follows:

Door Opening	Net Overall Size
2'6" x 6'8" (30" x 80")	2'8-1/2" x 6'9-1/2" (32-1/2" x 81-1/2")
2'8" x 6'8" (32" x 80")	2'10-1/2" x 6'9-1/2" (34-1/2" x 81-1/2")
3'0" x 6'8" (36" x 80")	3'2-1/2" x 6'9-1/2" (38-1/2" x 81-1/2")

Economy steel security door dimensions for the Flagstaff, Del Sol, Sedona, Monterrey & Woodguard:

A. The net overall size, which includes the 3-piece mounting frame, is as follows:

Door Opening	Net Overall Size
2'6" x 6'8" (30" x 80")	2'9" x 6'9-3/4" (33" x 81-3/4")
2'8" x 6'8" (32" x 80")	2'11" x 6'9-3/4" (35" x 81-3/4")
3'0" x 6'8" (36" x 80")	3'3" x 6'9-3/4" (39" x 81-3/4")

On products with perforated metal that is welded in place, the perforated metal may experience deformation and the item may have areas of insufficient finish.

To prevent oxidation (rust), touch up any scratches, chips, etc. with a quality rust inhibiting paint as soon as possible. In order to maintain a rust free finish, regularly inspect and re-paint as needed. In exposed, damp or coastal areas annual painting is recommended.

Features

- Standard size only - No custom sizes
3'0" x 6'8" (39" x 81-3/4")
- 1" x 1-1/2" x 18 Ga. pre-hung steel mounting frame
- 1" sq. x 18 Ga. steel door frame
- 1/2" sq. x 18 Ga. vertical pickets
- 3/4" sq. x 18 Ga. horizontal pickets
- Double hole lock-box w/ 2-1/8" bore & 2-3/8" backset
- Continuous 1/8" x 3/4" steel lock side "tamper guard"
- Tamper-proof hinges
- 24 Ga. expanded steel mesh for extra security
- Non-handed
- Precision SAFEGUARD packaging - complete with one-way mounting screws

Standard Finishes

- Black or white finish with matching expanded steel mesh
- No other color options available for this door

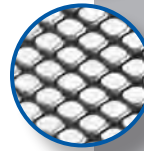
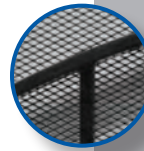
(Series 3809-I) **WOODGUARD****Features**

- Standard sizes only - No custom sizes
2'8" x 6'8" (35" x 81-3/4")
3'0" x 6'8" (39" x 81-3/4")
- 1-1/4" sq. x 18 Ga. pre-hung steel mounting frame
- 1" sq. x 18 Ga. steel door frame
- 3/4" Thick pine wood, colonial pattern with light oak stain insert
- Double hole lock-box w/ 2-1/8" bore & 2-3/8" backset
- Continuous 1/8" x 3/4" steel lock side "tamper guard"
- Tamper-proof hinges
- 24 Ga. perforated steel mesh for extra security
- Non-handed
- Precision SAFEGUARD packaging - complete with one-way mounting screws

Standard Finishes

- Bronze - light oak finish with bronze perforated steel mesh
- No other color options available for this door

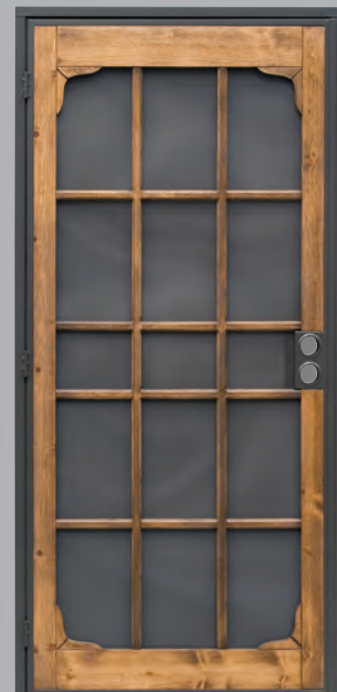
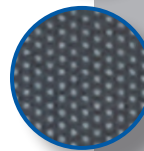

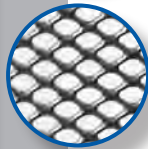

Features

- Standard size only - No custom sizes
3'0" x 6'8" (38-1/2" x 81-1/2")
- 1" sq. x 18 Ga. 3-piece steel mounting frame
- 3/4" sq. x 18 Ga. steel door frame
- 1/2" sq. x 18 Ga. vertical steel pickets
- 1/2" Flat bar horizontal steel pickets
- 1/8" Thick x 1/2" wide steel scroll design
- Double hole lock-box w/ 2-1/8" bore & 2-3/8" backset
- Tamper-proof hinges
- 24 Ga. expanded steel mesh for extra security
- Non-handed
- Precision SAFEGUARD packaging - complete with one-way mounting screws

Standard Finishes

- Black, bronze or white finish with matching expanded steel mesh
- No other color options available for this door

REGAL (Series 3818)

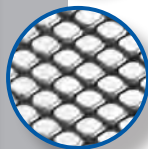
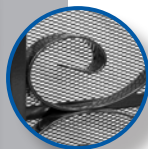

Features

- Standard sizes only - No custom sizes
2'6" x 6'8" (32-1/2" x 81-1/2")
2'8" x 6'8" (34-1/2" x 81-1/2")
3'0" x 6'8" (38-1/2" x 81-1/2")
- 1" sq. x 18 Ga. 3-piece steel mounting frame
- 3/4" sq. x 18 Ga. steel door frame
- 1/2" sq. x 18 Ga. vertical steel pickets
- 1/2" Flat bar horizontal steel pickets
- 1/8" Thick x 1/2" wide steel scroll design
- Double hole lock-box w/ 2-1/8" bore & 2-3/8" backset
- Tamper-proof hinges
- 24 Ga. expanded steel mesh for extra security
- Non-handed
- Precision SAFEGUARD packaging - complete with one-way mounting screws

Standard Finishes

- Black or white finish with matching expanded steel mesh
- No other color options available for this door

Features

- Standard sizes only - No custom sizes
2'8" x 6'8" (35" x 81-3/4")
3'0" x 6'8" (39" x 81-3/4")
- 1" sq. x 18 Ga. 3-piece steel mounting frame
- 3/4" sq. x 18 Ga. steel door frame
- 1/2" sq. x 18 Ga. vertical steel pickets
- 1/2" sq. x 18 Ga. horizontal steel pickets
- 1/8" Thick x 1/2" wide steel scroll design
- Double hole lock-box w/ 2-1/8" bore & 2-3/8" backset
- Tamper-proof hinges
- 24 Ga. expanded steel mesh for extra security
- Non-handed
- Precision SAFEGUARD packaging - complete with one-way mounting screws

Standard Finishes

- Black or white finish with matching expanded steel mesh
- No other color options available for this door



Features

- Standard sizes only - No custom sizes
2'8" x 6'8" (34-1/2" x 81-1/2")
3'0" x 6'8" (38-1/2" x 81-1/2")
- 1" sq. x 18 Ga. 3-piece steel mounting frame
- 3/4" sq. x 18 Ga. steel door frame
- 1/2" sq. x 18 Ga. vertical steel pickets
- 1/2" sq. Flat bar horizontal steel pickets
- 1/8" Thick x 1/2" wide steel scroll design
- Double hole lock-box w/ 2-1/8" bore & 2-3/8" backset
- Tamper-proof hinges
- 24 Ga. perforated steel mesh for extra security
- Non-handed
- Precision SAFEGUARD packaging - complete with one-way mounting screws

Standard Finishes

- Black, bronze or white with matching perforated steel mesh
- No other color options available for this door



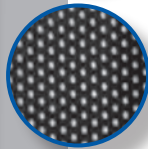

Features

- Standard size only - No custom sizes
3'0" x 6'8" (39" x 81-3/4")
- 1-1/4" sq. x 18 Ga. 3-piece steel mounting frame
- 1" sq. x 18 Ga. steel door frame
- 1/2" sq. x 18 Ga. vertical steel pickets
- 1/2" sq. x 18 Ga. horizontal steel pickets
- Two signature aluminum castings
- Double hole lock-box w/ 2-1/8" bore & 2-3/8" backset
- Tamper-proof hinges
- 24 Ga. perforated steel mesh for extra security
- Non-handed
- Precision SAFEGUARD packaging - complete with one-way mounting screws

Standard Finishes

- Black, bronze or white finish with matching perforated steel mesh
- No other color options available for this door

DEL SOL (Series 3833)

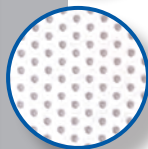
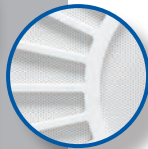

Features

- Standard sizes only - No custom sizes
2'8" x 6'8" (35" x 81-3/4")
3'0" x 6'8" (39" x 81-3/4")
- 1-1/4" sq. x 18 Ga. 3-piece steel mounting frame
- 1" x 2" x 18 Ga. steel door frame
- 1/2" sq. x 18 Ga. steel pickets
- Double hole lock-box w/ 2-1/8" bore & 2-3/8" backset
- Tamper-proof hinges
- 24 Ga. perforated steel mesh for extra security
- Non-handed
- Precision SAFEGUARD packaging - complete with one-way mounting screws

Standard Finishes

- Almond, black or white finish with matching perforated steel mesh
- No other color options available for this door

Features

- Standard sizes only - No custom sizes
2'8" x 6'8" (35" x 81-3/4")
3'0" x 6'8" (39" x 81-3/4")
- 1-1/4" sq. x 18 Ga. 3-piece steel mounting frame
- 1" x 2" x 18 Ga. steel door frame
- 1/2" sq. x 18 Ga. vertical steel pickets
- 1/2" sq. x 18 Ga. horizontal steel pickets
- Three signature aluminum castings
- Double hole lock-box w/ 2-1/8" bore & 2-3/8" backset
- Tamper-proof hinges
- 24 Ga. perforated steel mesh for extra security
- Non-handed
- Precision SAFEGUARD packaging - complete with one-way mounting screws



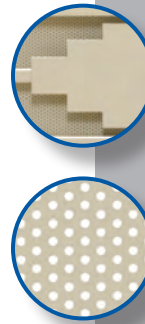

Standard Finishes

- Adobe or almond with matching perforated steel mesh
- No other color options available for this door

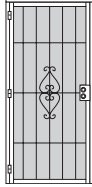

ECONOMY STEEL SECURITY DOORS Standard size security doors

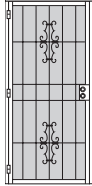
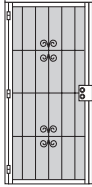
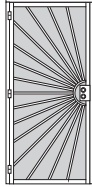
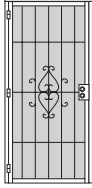
Economy steel security doors are only available in sizes and finishes listed below

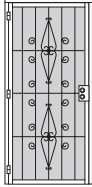
Name/ Series	Product Line	Description	Name/ Series	Product Line	Description
Monterrey 3836 Page 56	G3018	 <p>Available in 3'0" x 6'8" only 1" x 1-1/2" x 18 Ga. pre-hung mounting frame 1" sq. x 18 Ga. steel door frame 1/2" sq. x 18 Ga. vertical pickets 24 Ga. expanded steel mesh Black or white with matching expanded steel mesh</p>	Regent 3801 Page 58	G3018	 <p>Available in 2'8" & 3'0" x 6'8" only 1" sq. x 18 Ga. 3-piece mounting frame 3/4" sq. x 18 Ga. steel door frame (5) 1/2" sq. x 18 Ga. vertical pickets 1/8" Thick x 1/2" wide steel scroll design 24 Ga. perf. steel mesh for extra security Black, bronze or white with matching perforated steel mesh</p>
Woodguard 3809-I Page 56	G3018	 <p>Available in 2'8" & 3'0" x 6'8" only 1-1/4" sq. x 18 Ga. pre-hung mounting frame 1" sq. x 18 Ga. steel door frame 3/4" Thick colonial wood pattern 24 Ga. perf. steel mesh for extra security Bronze frame with matching perforated steel mesh and light oak stained wood insert</p>	Flagstaff 3853 Page 59	G3018	 <p>Available in 3'0" x 6'8" only 1-1/4" sq. x 18 Ga. 3-piece mounting frame 1" sq. x 18 Ga. steel door frame 1/2" sq. x 18 Ga. pickets 1 Pair Granada castings 24 Ga. perf. steel mesh for extra security Black, bronze or white with matching perforated steel mesh</p>
Valdor 3832 Page 57	G3018	 <p>Available in 3'0" x 6'8" only 1" sq. x 18 Ga. 3-piece mounting frame 3/4" sq. x 18 Ga. steel door frame 1/2" sq. x 18 Ga. pickets 1/8" Thick x 1/2" wide steel scroll design 24 Ga. expanded steel mesh Black, bronze or white with matching expanded steel mesh</p>	Del Sol 3833 Page 59	G3018	 <p>Available in 2'8" & 3'0" x 6'8" only 1-1/4" sq. x 18 Ga. 3-piece mounting frame 1" x 2" x 18 Ga. steel door frame 1/2" sq. x 18 Ga. pickets in sunburst pattern 24 Ga. perf. steel mesh for extra security Almond, black or white with matching perforated steel mesh</p>
Regal 3818 Page 57	G3018	 <p>Available in 2'6", 2'8" & 3'0" x 6'8" only 1" sq. x 18 Ga. 3-piece mounting frame 3/4" sq. x 18 Ga. steel door frame (5) 1/2" sq. x 18 Ga. vertical pickets 1/8" Thick x 1/2" wide steel scroll design 24 Ga. expanded steel mesh Black or white with matching expanded steel mesh</p>	Sedona 3854 Page 60	G3018	 <p>Available in 2'8" & 3'0" x 6'8" only 1-1/4" sq. x 18 Ga. 3-piece mounting frame 1" x 2" x 18 Ga. steel door frame 1/2" sq. x 18 Ga. pickets Sedona design top, bottom & center castings 24 Ga. perf. steel mesh for extra security Adobe or almond with matching perforated steel mesh</p>
Orleans 3851 Page 58	G3018	 <p>Available in 2'8" & 3'0" x 6'8" only 1" sq. x 18 Ga. 3-piece mounting frame 3/4" sq. x 18 Ga. steel door frame 1/2" sq. x 18 Ga. pickets 1/8" Thick x 1/2" wide steel scroll design 24 Ga. expanded steel mesh Black or white with matching expanded steel mesh</p>			

Limited warranty on economy security doors is 90 days after delivery.

SECTION 4 / SLIDING SCREEN DOORS

PRODUCT	PAGE
Aluminum roll form sliding screen door (assembled / KD).....	64
Extruded aluminum sliding screen doors (assembled / KD).....	64-65
Steel roll form sliding screen doors (assembled).....	66-67
Maui vinyl sliding screen door (assembled / KD)	67
Custom options for sliding screen doors (assembled / KD).....	68-69
Door list	70
Top hung universal mounting channel	71
Sliding screen channels and astragals	72
Sliding screen door measuring worksheet	73
Sliding screen door order form.....	74

Features

- 1-5/8" Roll form aluminum frame
- Black plastic **Anjac** handle assembly with strike plate & installation screws
- Non-handed with handle centered
- Stamped steel corners
- Charcoal fiberglass insect screening (on assembled doors)
- 1" Nylon spring tension roller with adjustment screw (plastic inserts are no longer standard)
- Extruded vinyl bug seal with flap & tear-off strips
- Assembled & K.D. widths available up to 61"
- Assembled & K.D. heights available up to 97" (specify handle height on doors over 84" tall)
- Precision SAFEGUARD packaging - complete with hardware (on assembled doors)

Standard Finishes

- Bronze, gray or white powder coated

Call for quote on any sizes or options not shown

3100 (Assembled)
Product Line: D3301

4100 (KD) *
Product Line: D3310

Door size up to

Door size up to

37" x 81"	37" x 97"
49" x 81"	49" x 97"
61" x 81"	61" x 97"

31" x 81"	31" x 97"
37" x 81"	37" x 97"
49" x 81"	49" x 97"
61" x 81"	61" x 97"

For KD kits - Convenient six pack packaging:
Deduct \$2.00 per door (subject to discount)

*All rails are miter cut

Roll Form Aluminum
Screen Door

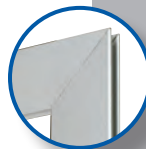

Features

- 1-3/4" .050 Extruded aluminum frame (fluted)
- Extruded aluminum handle assembly with mortise lock & lever latch
- Non-handed with handle centered
- Extruded aluminum spur corners
- Charcoal fiberglass insect screening (on assembled doors)
- 1" Steel ball bearing spring tension roller with adjustment screw (plastic inserts are no longer standard)
- Extruded vinyl bug seal with flap & tear-off strips
- Assembled & K.D. widths available up to 73"
- Assembled & K.D. heights available up to 110" (specify handle height on doors over 84" tall)
Extra charges will apply for doors over 97" in height
- Precision SAFEGUARD packaging - complete with hardware (on assembled doors)

Standard Finishes

- Adobe, almond, black, bronze or white powder coated
- Satin anodized

Call for quote on any sizes or options not shown

3200 (Assembled)
Product Line: D3302

4200 (KD) **
Product Line: D3311

Door size up to*

Door size up to*

37" x 81"	37" x 97"	37" x 110"
49" x 81"	49" x 97"	49" x 110"
61" x 81"	61" x 97"	61" x 110"
73" x 81"	73" x 97"	73" x 110"

31" x 81"	31" x 97"	31" x 110"
37" x 81"	37" x 97"	37" x 110"
49" x 81"	49" x 97"	49" x 110"
61" x 81"	61" x 97"	61" x 110"

*Doors over 97" tall are subject to an additional charge

For KD kits - Convenient six pack packaging:
Deduct \$2.00 per door (subject to discount)

**Miter cut service available for an additional charge

Extruded Aluminum
Screen Door

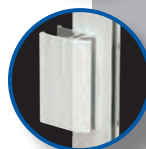

Extruded Aluminum Screen Door

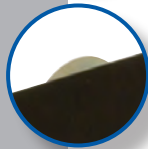
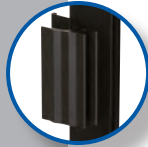
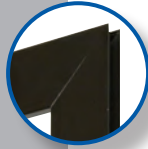

Features

- 1-3/4" .050 Extruded aluminum frame
- Extruded aluminum handle assembly with mortise lock & lever latch
- Non-handed with handle centered
- Heavy duty diecast corners with side adjustment
- Charcoal fiberglass insect screening (on assembled doors)
- 1-1/4" Steel ball bearing rollers
- Extruded vinyl bug seal with flap & tear-off strips
- Assembled & K.D. widths available up to 73"
- Assembled & K.D. heights available up to 110" (specify handle height on doors over 84" tall)
Extra charges will apply for doors over 97" in height
- Precision SAFEGUARD packaging - complete with hardware (on assembled doors)

Standard Finishes

- Adobe, almond, black, bronze or white powder coated
- Bronze or satin anodized

Call for quote on any sizes or options not shown

3300 (Assembled) Product Line: D3302

Door size up to*		
37" x 81"	37" x 97"	37" x 110"
49" x 81"	49" x 97"	49" x 110"
61" x 81"	61" x 97"	61" x 110"
73" x 81"	73" x 97"	73" x 110"

*Doors over 97" tall are subject to an additional charge

4300 (KD) ** Product Line: D3311

Door size up to*		
31" x 81"	31" x 97"	31" x 110"
37" x 81"	37" x 97"	37" x 110"
49" x 81"	49" x 97"	49" x 110"
61" x 81"	61" x 97"	61" x 110"

For KD kits - Convenient six pack packaging:
Deduct \$2.00 per door (subject to discount)

**Miter cut service available for an additional charge

MARQUIS (Series 3400 Assembled / 4400 KD)

Extruded Aluminum Screen Door

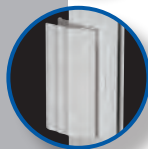

Features

- 2-1/2" .060 Extruded aluminum frame (fluted)
- Extruded aluminum handle assembly with mortise lock & lever latch
- Extruded aluminum spur corners
- Charcoal fiberglass insect screening (on assembled doors)
- 1" Steel ball bearing spring tension top rollers
- 1-1/4" Steel ball bearing bottom rollers
- Extruded vinyl bug seal with flap & tear-off strips

Specify handing: latch side, left or right as viewed from outside looking in

- Assembled & K.D. widths available up to 73"
- Assembled & K.D. heights available up to 110" (specify handle height on doors over 84" tall)
Extra charges will apply for doors over 97" in height
- Precision SAFEGUARD packaging - complete with hardware (on assembled doors)

Standard Finishes

- Adobe, almond, black, bronze or white powder coated
- Satin anodized

Call for quote on any sizes or options not shown

3400 (Assembled) Product Line: D3302

Door size up to*		
37" x 81"	37" x 97"	37" x 110"
49" x 81"	49" x 97"	49" x 110"
61" x 81"	61" x 97"	61" x 110"
73" x 81"	73" x 97"	73" x 110"

*Doors over 97" tall are subject to an additional charge

4400 (KD) ** Product Line: D3311

Door size up to*		
31" x 81"	31" x 97"	31" x 110"
37" x 81"	37" x 97"	37" x 110"
49" x 81"	49" x 97"	49" x 110"
61" x 81"	61" x 97"	61" x 110"

**Miter cut service available for an additional charge

Features

- 2-1/4" x 1" .050 Extruded "hat section" style aluminum frame (smooth)
- Recessed handle assembly with mortise lock & slide latch
- Non-handed with handle centered
- Extruded aluminum spur corners
- Charcoal fiberglass insect screening (on assembled doors)
- 1-1/4" Steel ball bearing rollers
- Extruded vinyl bug seal with flap & tear-off strips
- Assembled & K.D. widths available up to 73"
- Assembled & K.D. heights available up to 110" (specify handle height on doors over 84" tall)
Extra charges will apply for doors over 97" in height
- Precision SAFEGUARD packaging - complete with hardware (on assembled doors)

Standard Finishes

- Adobe, almond, bronze or white powder coated
- Satin anodized

Call for quote on any sizes or options not shown

3500 (Assembled) Product Line: D3302		
Door size up to*		
37" x 81"	37" x 97"	37" x 110"
49" x 81"	49" x 97"	49" x 110"
61" x 81"	61" x 97"	61" x 110"
73" x 81"	73" x 97"	73" x 110"

*Doors over 97" tall are subject to an additional charge

4500 (KD) ** Product Line: D3312		
Door size up to*		
31" x 81"	31" x 97"	31" x 110"
37" x 81"	37" x 97"	37" x 110"
49" x 81"	49" x 97"	49" x 110"
61" x 81"	61" x 97"	61" x 110"

**Miter cut service available for an additional charge

Extruded "Hat Section" Aluminum Screen Door

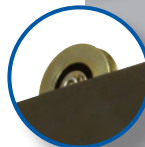
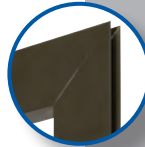

Features

- 1-5/8" Roll form steel frame
- Height adjustable from 79-3/8" to 80-3/4" (for height adjustments between 78-1/2" and 79", remove top hood assembly)
- 30", 36" & 48" Standard sizes
- Black plastic "Precision" handle assembly
- Non-handed
- Stamped steel corners
- Charcoal fiberglass insect screening
- Nylon spring tension roller assembly
- Top roller attached to adjustment channel
- Extruded vinyl bug seal with flap & tear-off strips
- No custom sizes or options
- Precision SAFEGUARD packaging - complete with hardware

Standard Finishes

- Bronze, gray or white

Economy Roll Form Steel Screen Door



3700 (Assembled)
Product Line: D3005

Standard sizes available

30"
36"
48"

Economy Roll Form Steel Screen Door



Features

- 1-5/8" Roll form steel frame with hat section
- Height adjustable from 79-3/8" to 80-3/4" (for height adjustments between 78-1/8" and 79", remove top hood assembly)
- 36" & 48" Standard size only
- Black plastic "Superior" handle assembly
- Non-handed
- Stamped steel corners
- Charcoal fiberglass insect screening
- Nylon spring tension roller assembly
- Extruded vinyl bug seal with flap & tear-off strips
- No custom sizes or options
- Precision SAFEGUARD packaging - complete with hardware

Standard Finishes

- Bronze, gray or white

3751 (Assembled)

Product Line: D3005

Standard sizes available

36"
48"

MAUI (Series 3600 Assembled / 4600 KD)

Reinforced Vinyl Screen Door

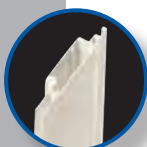

Features

- 2-1/4" x 1" Reinforced vinyl frame (smooth)
- Black plastic handle assembly
- Non-handed with handle centered
- Factory welded corners on assembled doors
- Heavy duty PVC corners with KD kits
- Charcoal fiberglass insect screening (on assembled doors)
- 1" Stainless steel ball bearing rollers with stainless steel adjusting screws
- Extruded vinyl bug seal with flap & tear-off strips
- **Specify handing: latch side, left or right as viewed from outside looking in**
- Assembled & K.D. widths available up to 61"
- Assembled & K.D. heights available up to 96"
- Corrosion resistant
- Cannot use Suntex on this door series
- Precision SAFEGUARD packaging - complete with hardware (on assembled doors)

Standard Finishes

- White vinyl

Call for quote on any sizes or options not shown

3600 (Assembled)

Product Line: D3600

Door size up to: *

37" x 81"	37" x 96"
49" x 81"	49" x 96"
61" x 81"	61" x 96"

4600 (KD)

Product Line: D3600

Door size up to:

37" x 81"	37" x 96"
49" x 81"	49" x 96"
61" x 81"	61" x 96"

*Dimension tolerances on assembled doors +/- 3/32" (3/16" overall)

SLIDING SCREEN DOORS

Custom options (add-ons)









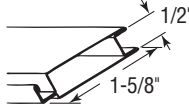

Option	Option Code	Description
Door frame options	OP-1PB-1	Install 1 each #288PB – 1-1/8" extruded push bar
	OP-1PB-2	Install 2 each #288PB – 1-1/8" extruded push bar
	OP-CRNSCR	Install 4 screws in each corner; total 16 screws
	OP-NOSLOT-HARDW	No latch, handles, rollers; no punch or slotting
	OP-SLSLOT4HNDL	Sliding door handle height; punch XX-x/x" up from bottom to
Roller options	OP-CLASSIC-N	Install classic side adjust nylon rollers (#477002N)
	OP-MARQUIS-NB	Slot & install Marquis nylon ball bearing rollers bottom (#4828N)
	OP-MARQUIS-NT	Slot & install Marquis nylon ball bearing rollers top (#4830)
	OP-MARQUIS-NTB	Slot & install Marquis nylon ball bearing rollers top & bottom (#4830 & #4828N)
	OP-MARQUIS-SB	Slot & install Marquis steel ball bearing rollers bottom (#4828)
	OP-MARQUIS-ST	Slot & install Marquis steel ball bearing rollers top (#4830)
	OP-MARQUIS-STB	Slot & install Marquis steel ball bearing rollers top & bottom (#4830 & #4828)
	OP-MARQUIS-SSB	Slot & install Marquis stainless steel ball bearing rollers bottom (#4828SS)
	OP-MARQUIS-SST	Slot & install Marquis stainless steel ball bearing rollers top (#4830SS)
	OP-MARQUIS-SSTB	Slot & install marquis stainless steel ball bearing rollers top & bottom (#4830SS & #4828SS)
	OP-REGAL-S	Install Regal steel rollers top & bottom #4131
	OP-REGAL-SS	Install Regal stainless steel ball bearing rollers #4131-SS
Handing options	OP-HNDLLEFT	XO"" Handle left from the outside looking in
	OP-HNDLRIGHT	OX"" Handle right from the outside looking in
Handle options	OP-1HNDL4227	Install Anjac handle #4227
	OP-2HNDL4227	Install Anjac handle #4227
	OP-1HNDL4230	Install Superior handle #4230
	OP-1HNDL4736	Install latch & flush handle inside & out #4736 w/latch
	OP-1HNDL4736-NS	No slot/no latch, install flush handles inside & out #4736
Grille options	OP-GREMPRESS-30	Install Empress heavy duty grille 30"
	OP-GREMPRESS-36	Install Empress heavy duty grille 36"
	OP-GREMPRESS-48	Install Empress heavy duty grille 48"
	OP-GREMPRESS-60	Install Empress heavy duty grille 60"
	OP-GRFIESTA-30	Install Fiesta grille 30"
	OP-GRFIESTA-36	Install Fiesta grille 36"
	OP-GRFIESTA-48	Install Fiesta grille 48"
	OP-GRFIESTA-60	Install Fiesta grille 60"

SLIDING SCREEN DOORS

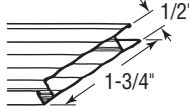
Custom options (add-ons)

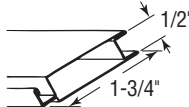
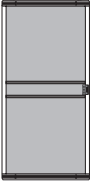
Option	Option Code	Description
Pet door options	OP-PD-SLD-S	Install pet door handle side – small w/adapter
	OP-PD-SLD-M	Install pet door handle side – medium w/adapter
	OP-PD-SLD-L	Install pet door handle side – large w/adapter
Pet door colors	OP-AD	Adobe
	OP-AL	Almond
	OP-BZ	Bronze
	OP-SA	Satin anodized
	OP-WH	White
Screen cloth options	OP-SC14CF	Screen cloth charcoal fiber 18" x 14"
	OP-SC14GF	Screen cloth gray fiber 18" x 14"
	OP-SC16BA	Screen cloth brite aluminum 18" x 16"
	OP-SC16BV	Screen cloth better vue
	OP-SC16CA	Screen cloth charcoal aluminum 18" x 16"
	OP-SC16CF	Screen cloth charcoal fiber 18" x 16"
	OP-SC16GF	Screen cloth gray fiber 18" x 16"
	OP-SC16UV	Screen cloth ultra vue
	OP-SC20CF	Screen cloth charcoal fiber 20" x 20"
	OP-SCD	Delete screen cloth & spline; door shell only
	OP-SCPSBK	Screen cloth black petscreen
	OP-SCPSLBK	Screen cloth black petscreen lite
	OP-SCPSGR	Screen cloth gray petscreen
	OP-SCSSCF	Screen cloth charcoal sunscreen
	OP-SCSSGF	Screen cloth gray sunscreen
	OP-SCSTBK	Screen cloth black sun tex 80%
	OP-SCSTBR	Screen cloth brown sun tex 80%
	OP-SCSTGR	Screen cloth gray sun tex 80%
OP-SCSTST	Screen cloth stucco sun tex 80%	

SLIDING SCREEN DOORS Assembled lines only

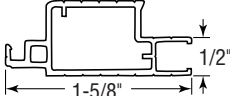
Name/ Series	Product Line	Description	Name/ Series	Product Line	Description
Brentwood 3100 Page 64	D3301	 <p>1-5/8" Roll form aluminum frame Custom widths 37" up to 61", Heights up to 97" Black plastic Anjac handle assembly with strike plate & installation screws Bronze, gray or white No custom colors available for this door</p> 	Prestige 3500 Page 66	D3302	 <p>2-1/4" x 1" .050 Extruded "hat section" style aluminum frame (smooth) Custom widths 37" up to 73", Heights up to 110" * Recessed handle assembly with mortise lock & slide latch Adobe, almond, bronze or white Satin anodized No custom colors available for this door</p> 
Regal 3200 Page 64	D3302	 <p>1-3/4" .050 Extruded aluminum frame (fluted) Custom widths 37" up to 73", Heights up to 110" * Extruded aluminum handle assembly with mortise lock & lever latch Adobe, almond, black, bronze or white Satin anodized No custom colors available for this door</p> 	Breezeway 3700 Page 66	D3005	 <p>1-5/8" Roll form steel frame Available in 30", 36" & 48" only Black plastic "Precision" handle assembly Bronze, gray or white No custom sizes or colors available for this door</p>
Classic 3300 Page 65	D3302	 <p>1-3/4" .050 Extruded aluminum frame Custom widths 37" up to 73", Heights up to 110" * Extruded aluminum handle assembly with mortise lock & lever latch Adobe, almond, black, bronze or white Bronze or satin anodized No custom colors available for this door</p> 	Branson 3751 Page 67	D3005	 <p>1-5/8" Roll form steel frame with hat section Available in 36" & 48" only Black plastic "Superior" handle assembly Bronze, gray or white No custom sizes or colors available for this door</p>
Marquis 3400 Page 65	D3302	 <p>2-1/2" .060 Extruded aluminum frame (fluted) Custom widths 37" up to 73", Heights up to 110" * Extruded aluminum handle assembly with mortise lock & lever latch Adobe, almond, black, bronze or white Satin anodized No custom colors available for this door</p> 	Maui 3600 Page 67	D3600	 <p>2-1/4" x 1" Reinforced vinyl frame (smooth) Custom widths 37" up to 61", Heights up to 96" Black plastic handle assembly Corrosion resistant White No custom colors available for this door</p> 

***Extra charges will apply for doors over 97" in height**

TOP HUNG UNIVERSAL MOUNTING CHANNEL

For sliding screen doors

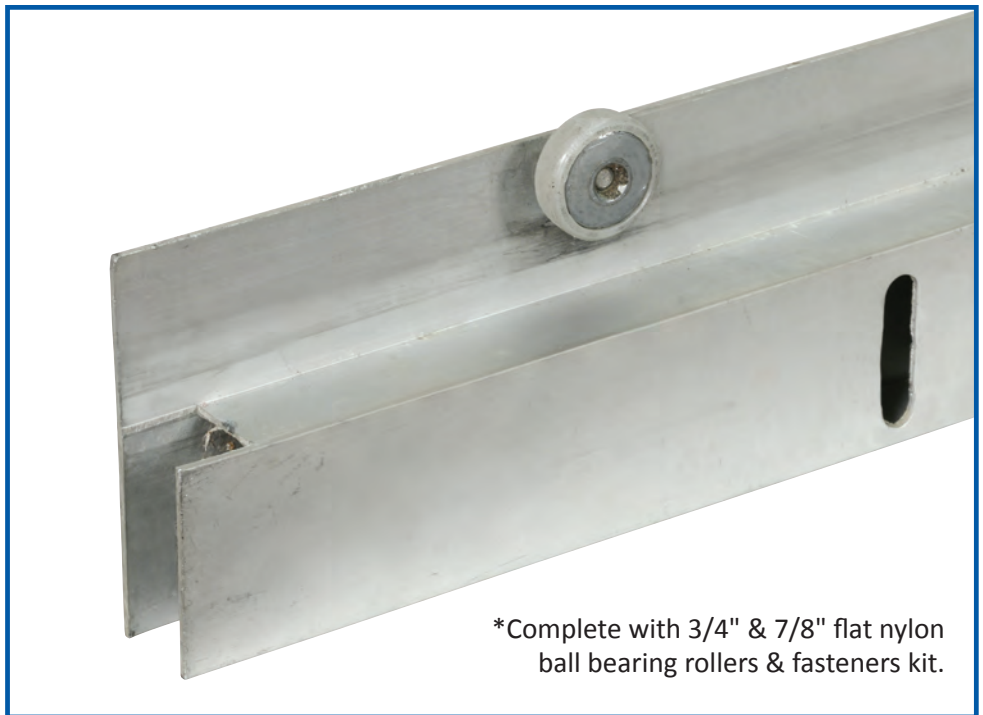
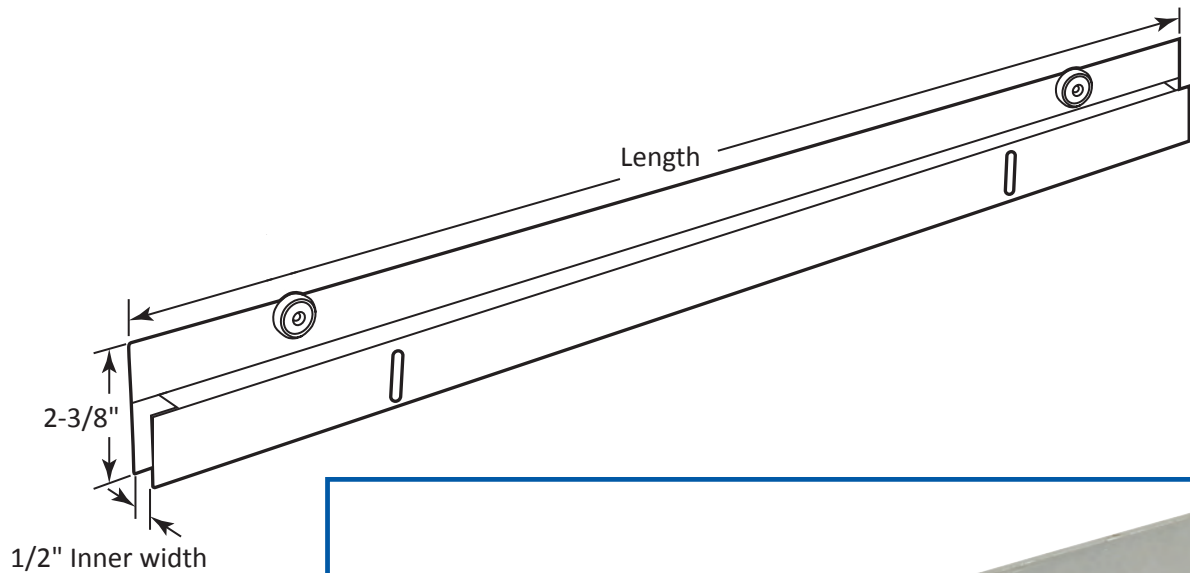

*** FITS MOST DOOR SERIES**
BRENTWOOD, REGAL, CLASSIC, MARQUIS

4848AD-36
4848AL-36
4848BZ-36
4848SA-36
4848WH-36

4848AD-48
4848AL-48
4848BZ-48
4848SA-48
4848WH-48

SLIDING SCREEN COMPONENTS

Color code chart (xx)		
AD = Adobe	BK = Black	ML = Mill
AL = Almond	BZ = Bronze	SA = Satin anodized
BA = Bronze anodized	GR = Gray	WH = White

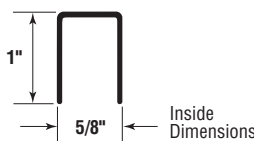
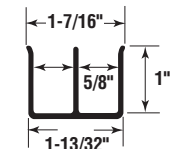
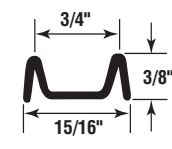
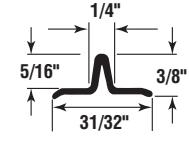
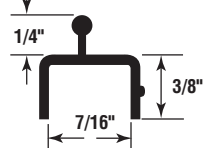
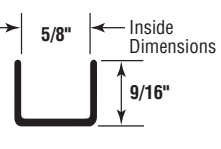
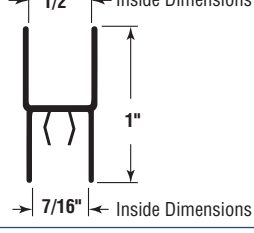
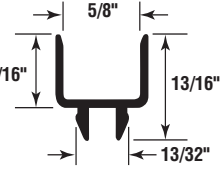
Part No.	Product Line	Description	Drawing
4180xx	F3874	5/8" x 1" Top single track 12' <i>(Available in all colors except gray)</i>	
4181xx	F3874	5/8" x 1" Top double track 12' <i>(Available in all colors except gray)</i>	
4184xx	F3874	Bottom double track 12' <i>(Available in all colors except gray)</i>	
4185xx	F3874	Single bottom track 12' <i>(Available in all colors except gray)</i>	
4189WH-8 4189WH	F3870 F3870	Extruded vinyl track 8' Extruded vinyl track 16' <i>(Available in white only)</i>	
4195xx	F3874	5/8" x 1/2" Top single track 12' <i>(Available in all colors except gray)</i>	
4198xx-84 4198BK-96 4198xx-100	F3874 F3874 F3874	Rigid vinyl astragal - 84" (all available colors) Rigid vinyl astragal - 96" (black only) Rigid vinyl astragal - 100" (AL not available) <i>(Available colors: AD, AL, BK, BZ, GR & WH)</i>	
4199xx84 4199xx	F3874 F3874	Used for extruded sliders Extruded screen astragal - 7' Extruded screen astragal - 8' <i>(Available in all colors except gray)</i>	

SLIDING PATIO SCREEN DOOR

Measuring worksheet

Step #1

Determine type of header:

Determine what type of header you have; **Top "track"** or **Top "channel"** from the 2 examples in *Diagram A* on the right.

*Note: If your door is something other than either of the examples in *Diagram A*, we recommend using Lowe's Installation professionals.

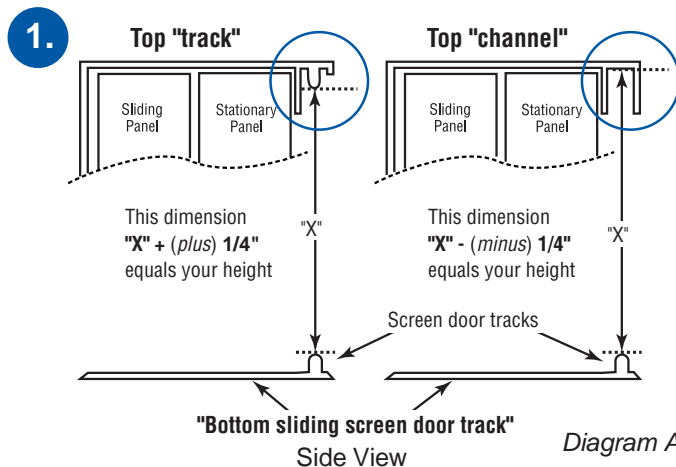

Step #2

Determine Door Height:

To determine the height of your door, measure from the top of the screen door **Top "track"** or **Top "channel"** to the top of the **"bottom sliding screen door track"** as shown. Make height measurements in 3 locations, the center and each end. There may be some "Sag", "Dip" or "Crown" along the door frame on older homes, so use the **SHORTEST** measurement for the final height of your door using the formula in *Diagram A*.

Make height measurements in 3 locations, the center and each end. There may be some "Sag", "Dip" or "Crown" along the door frame on older homes, so use the **SHORTEST** measurement for the final height of your door using the formula in *Diagram A*.

Example: using *Diagram A* formulas and shortest measurement for a door being 80":

"track" formula: $80" + 1/4" = 80-1/4"$

"channel" formula: $80" - 1/4" = 79-3/4"$

Net Door Height: _____ "

2. Determine Height

3. Determine Width

Step #3

Determine Door Width:

To determine the width, measure from the edge of the side jamb to approximately 1" past the "sliding" glass door panel (see *Diagram B*)

Net Door Width: _____ "

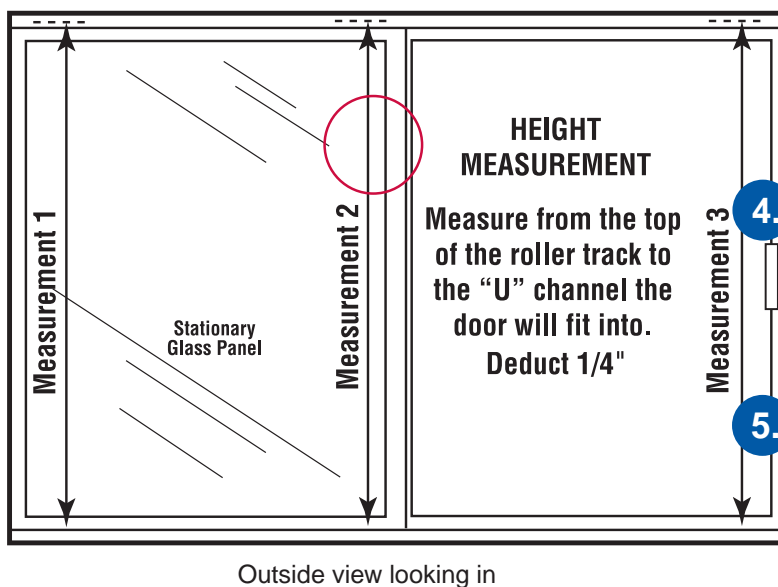

Step #4

Handle:

Please specify placement as either left or right as seen looking from the outside of the door in. (*Right hand showing in diagram*)

Handle side: Left Right

Step #5

Handle Height:

Handle will be centered unless specified. To order a special handle height placement, measure from the bottom of the door to center of handle.

Special Handle Height: _____ "
(Not required for normal installations)

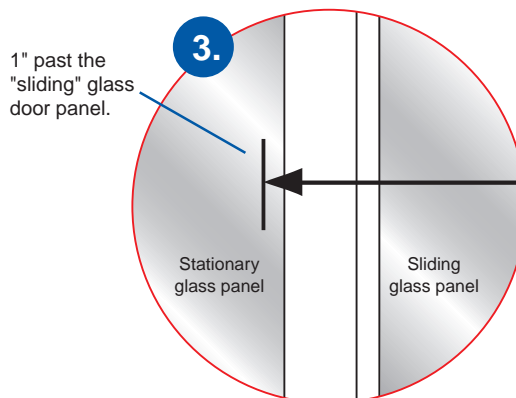

Diagram B

Note: If you have an existing OEM Screen Door, compare your measurements with the size of the door that you are replacing.

Patio Door Quick Fax Form

Fax to (909) 379-0169

Phone (909) 379-0123 • (866) 629-6636

Customer Name _____ Acct # _____ Customer Phone# _____

Contact Name _____ Customer Fax # _____

PO # Job/Customer Name _____ **QUOTE ONLY** **ORDER**

Qty	Net Door Size	Door Name	Door Color	Screen (Fabric / Color)	Handle Side	Handle Height	Notes & Options Instructions

**Note: Specify Handle side from the outside looking in.*

SECTION 5 / WOOD & VINYL SCREEN DOORS

PRODUCT	PAGE
Wood doors.....	76-77
Vinyl doors.....	78
Door list.....	79

WOOD SCREEN DOOR ACCESSORIES

- 3920HDW-118 Bronze push button hardware kit for 1-1/16" wood door
- 3920HDW-WH-118 White push button hardware kit for 1-1/16" wood door

Features

- 1-1/16" x 2-1/4" Frame
- Standard sizes only - No custom sizes
30" x 80-1/2"
32" x 80-1/2"
36" x 80-1/2"
- Pinewood finger jointed frame
- Hardware sold separately

Standard Finishes

- Natural – unfinished

Sold in packs
of four (4)

Economy Wood Screen Door



Features

- 1-1/16" x 2-1/4" Frame
- Standard sizes only - No custom sizes
30" x 80-1/2"
32" x 80-1/2"
36" x 80-1/2"
- Pinewood finger jointed frame
- Hardware sold separately

Standard Finishes

- Natural – unfinished

Sold in packs
of four (4)

Economy Wood Screen Door



Economy Wood Screen Door



Features

- 1-1/16" x 3-1/8" Frame
- Standard sizes only - No custom sizes
32" x 80-1/2"
36" x 80-1/2"
- Pinewood finger jointed frame
- Hardware sold separately

Standard Finishes

- Natural – unfinished

Sold in packs
of four (4)

9 PANEL (Series 3942)

Economy Wood Screen Door



Features

- 1-1/16" x 3" Frame
- Standard sizes only - No custom sizes
32" x 80-1/2"
36" x 80-1/2"
- Pinewood finger jointed frame
- Hardware sold separately

Standard Finishes

- Natural – unfinished

Sold in packs
of four (4)

Features

- 1-1/8" x 2" Low maintenance hollow vinyl frame
- Standard sizes only - No custom sizes
32" x 80"
36" x 80"
- Includes hardware pack (black)

Standard Finishes

- White vinyl only

Sold in packs of four (4)

Precision screen door side and bottom adjustment channels allow for a standard size door to fit most applications. After measuring your opening, use this chart and determine if a standard door will fit.

Standard Door Width	Fits Openings From
36" Door - 35"	35-1/2" up to 36-5/8"
32" Door - 31"	31-1/2" up to 32-5/8"
30" Door - 29"	29-1/2" up to 30-5/8"
Standard Door Height	Fits Openings From
79-1/4"	80" up to 81"



Economy Vinyl Screen Door



Features

- 1-1/8" x 2" Low maintenance hollow vinyl frame
- Standard size only - No custom sizes
36" x 80"
- Includes hardware pack (black)

Standard Finishes

- White vinyl only

Sold in packs of four (4)

Precision screen door side and bottom adjustment channels allow for a standard size door to fit most applications. After measuring your opening, use this chart and determine if a standard door will fit.

Standard Door Width	Fits Openings From
36" Door - 35"	35-1/2" up to 36-5/8"
Standard Door Height	Fits Openings From
79-1/4"	80" up to 81"



Economy Vinyl Screen Door

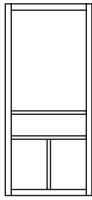
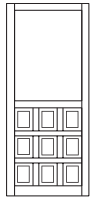
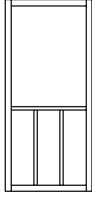
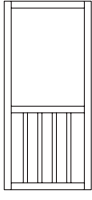
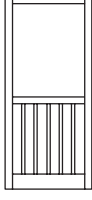
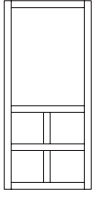

WOOD & VINYL SCREEN DOORS Economy line

Name/ Series	Product Line	Description	Name/ Series	Product Line	Description
Dogwood 3950 Page 76	D3025	 <p>1-1/16" x 2-1/4" Wood frame Available in 30", 32" & 36" x 80-1/2" Hardware sold separately Natural – unfinished No custom sizes or finishes</p>	9 Panel 3942 Page 77	D3025	 <p>1-1/16" x 3-1/8" Wood frame Available in 32" & 36" x 80-1/2" Hardware sold separately Natural – unfinished No custom sizes or finishes</p>
Aspen 3951 Page 76	D3025	 <p>1-1/16" x 2-1/4" Wood frame Available in 30", 32" & 36" x 80-1/2" Hardware sold separately Natural – unfinished No custom sizes or finishes</p>	Magnolia 3670N Page 78	D3610	 <p>1-1/8" x 2" Hollow vinyl frame Available in 32" & 36" x 80" Hardware pack included (black) White No custom sizes or finishes</p>
Nantucket 3952 Page 77	D3025	 <p>1-1/16" x 3-1/8" Wood frame Available in 32" & 36" x 80-1/2" Hardware sold separately Natural – unfinished No custom sizes or finishes</p>	Vermont 3671N Page 78	D3610	 <p>1-1/8" x 2" Hollow vinyl frame Available in 36" x 80" Hardware pack included (black) White No custom sizes or finishes</p>

SECTION 6 / STEEL STORM DOORS

PRODUCT	PAGE
Steel storm doors	82-83
Steel storm door list & options.....	84
Steel storm door mounting variation details.....	85
Steel storm door quick fax order form	86

DOMESTIC STEEL STORM DOORS

This section includes photographs and specifications of Precision’s line of steel security products. These products are manufactured at our Redlands, CA facility. All items are welded, assembled and finished using high quality raw materials and state of the art equipment. For a complete catalog of Precision products, or if you have any question regarding any Precision products or specifications, please contact your Precision representative or call Precision customer service.

All domestic precision steel security doors have a (1) one year warranty. (Refer to the “Terms and Conditions” page for details.)

The pictures shown may illustrate optional finishes. Steel security storm doors are built to order, and may take 4-6 weeks to build once order is placed.

Precision steel security doors come standard as surface mount. (Refer to Page 81, for mounting variations.)

The standard sizes indicated in this section represent “industry standard” door openings.

Steel security storm door dimensions:

A. The net overall size, which includes the pre-hung perimeter frame, is as follows:

Door Opening	Net Overall Size
2'6" x 6'8" (30" x 80")	2'9" x 6'9-3/4" (33" x 81-3/4")
2'8" x 6'8" (32" x 80")	2'11" x 6'9-3/4" (35" x 81-3/4")
3'0" x 6'8" (36" x 80")	3'3" x 6'9-3/4" (39" x 81-3/4")

B. When ordering surface mounted, custom size steel security storm doors: add 3" to the opening width & 1-3/4" to the opening height

NOTE: MOST ALL SECURITY DOOR PATTERNS ARE AVAILABLE IN STORM DOOR CONFIGURATIONS.

- Provides a thermal barrier to help improve energy efficiency
- Add a hexagonal perforated panel for greater security & seasonal air flow
- 1/8" Thick security glass available



Features

- 1-1/4" sq. x 18 Ga. one piece - 3 sided frame
- Custom sizes available
- 1" x 2-1/2" 16 Ga. steel door frame
- 5/8" sq. x 18 Ga. vertical steel pickets
- 1/2" sq. x 18 Ga. horizontal steel pickets
- Polished brass handle w/mortise lock & dead-bolt
- Continuous 1/8" x 1" "tamper guard" on strike & top
- Tamper proof hinges
- Removable tempered glass panel w/weatherstrip
- Removable screen panel
- Foam weather stripping
- **Specify left or right side hinge**
- 1/4" Thick laminate security glass available
- Precision SAFEGUARD packaging - complete with one-way mounting screws

Standard Finishes

- Adobe, almond, black, bronze, weathered brown or white powder coated



Features

- 1-1/4" sq. x 18 Ga. one piece - 3 sided frame
- Custom sizes available
- 1" x 2-1/2" 16 Ga. steel door frame
- 5/8" sq. x 18 Ga. vertical steel pickets
- 1/2" sq. x 18 Ga. horizontal steel pickets
- Polished brass handle w/mortise lock & dead-bolt
- Continuous 1/8" x 1" "tamper guard" on strike & top
- Tamper proof hinges
- Removable tempered glass panel w/weatherstrip
- Removable screen panel
- Foam weather stripping
- **Specify left or right side hinge**
- 1/4" Thick laminate security glass available
- Precision SAFEGUARD packaging - complete with one-way mounting screws

Standard Finishes

- Adobe, almond, black, bronze, weathered brown or white powder coated





Features



- 1-1/4" sq. x 18 Ga. one piece - 3 sided frame
- Custom sizes available
- 1" x 2-1/2" 16 Ga. steel door frame
- 1" x 2-1/2" 16 Ga. steel horizontal tubes at lock-box
- 1/2" sq. x 18 Ga. vertical steel pickets (2 twisted - 3 straight)
- 8 Signature aluminum castings
- Polished brass handle w/mortise lock & dead-bolt
- Continuous 1/8" x 1" "tamper guard" on strike & top
- Tamper proof hinges
- 2 Piece removable tempered glass panels w/weatherstrip
- 2 Piece removable screen panels
- Foam weather stripping
- **Specify left or right side hinge**
- 1/4" Thick laminate security glass available
- Precision SAFEGUARD packaging - complete with one-way mounting screws

Standard Finishes

- Adobe, almond, black, bronze, weathered brown or white powder coated

STEEL STORM DOORS

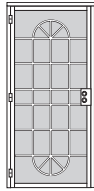
Doors manufactured domestically

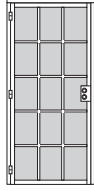
Name/ Series	Product Line	Description	Name/ Series	Product Line	Description
Clarion 3906 Page 80	G3012	 <p>1-1/4" sq. x 18 Ga. one piece - 3 sided frame Custom sizes available Removable tempered glass panel w/weatherstrip 1/4" Thick laminate security glass available Adobe, almond, black, bronze, weathered brown or white powder coated</p>	Imperial 3905 Page 81	G3012	 <p>1-1/4" sq. x 18 Ga. one piece - 3 sided frame Custom sizes available 2 Piece removable tempered glass panel w/weatherstrip 1/4" Thick laminate security glass available Adobe, almond, black, bronze, weathered brown or white powder coated</p>
Carolina 3907 Page 80	G3012	 <p>1-1/4" sq. x 18 Ga. one piece - 3 sided frame Custom sizes available Removable tempered glass panel w/weatherstrip 1/4" Thick laminate security glass available Adobe, almond, black, bronze, weathered brown or white powder coated</p>			

STEEL STORM DOORS

Custom options (add-ons)

Product Line Z9999 for all options on this page

Option	Option Code	Description
Mounting Variations (Refer to Page 81)	OP-SurfaceMt	Surface mount (standard)
	OP-InsetMt	Inset mount
	OP-InstMtTab	Inset mount w/tabs (specify tab size)
	OP-SurfMtTab	Surface mount w/tabs (specify tab size)
	OP-SMStndOffTab	Surface mount w/stand-off tabs (1-1/2" = OP-53 or 2" = OP-542)
	OP-SMTubeBack	Surface mount w/tube backing
	OP-IMFullStrap	Inset mount w/full strapping (specify strapping width)
	OP-IMSurfTab	Inset mount w/surface tabs (specify tab size)
Frame Variations	OP-1Pc3Side	One piece 3-sided pre-hung frame (standard)
	OP-1Pc4Side	One piece 4-sided pre-hung frame
Double Door	OP-DDFlushBolts	Set-up (price of two custom doors and add:) Double door w/flush extension bolts in door stile
Hardware	OP-SpecLBOc	Specify handle location
Door Coverings	OP-24GaPerf	Removable 24 Ga. perforated steel mesh w/ 3/32" dia holes (specify color)
Hydraulic Closer	OP-HydraulicClr	Hydraulic closer installed with mounting plates welded to frame & door

STORM DOOR MOUNTING VARIATIONS

SURFACE MOUNT

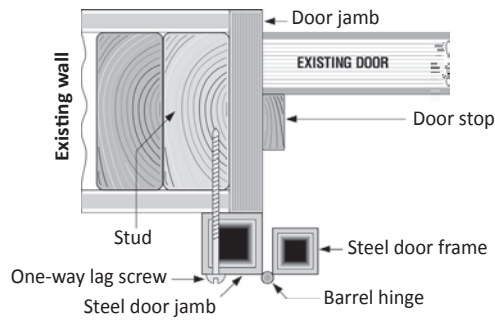

Surface mount standard

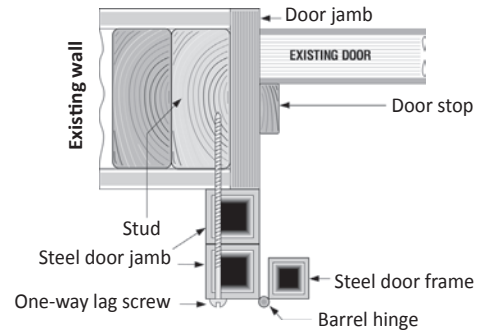

Surface mount w/tube backing

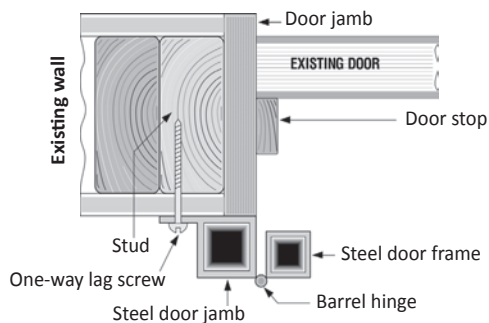

Surface mount w/tabs

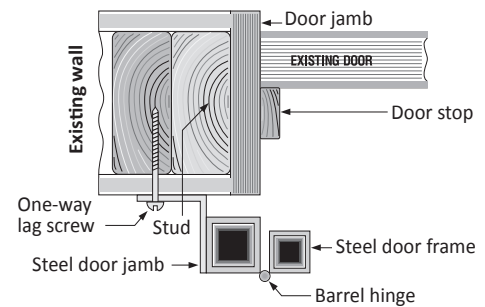

Surface mount w/stand-off tabs

INSET MOUNT

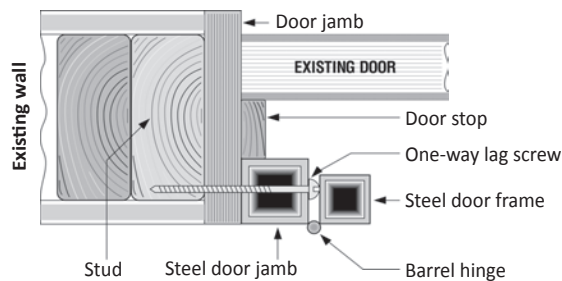

Inset mount

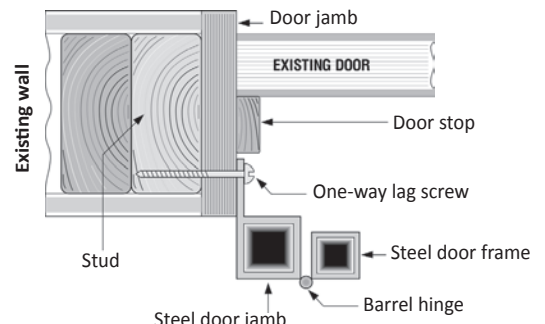

Inset mount w/tab

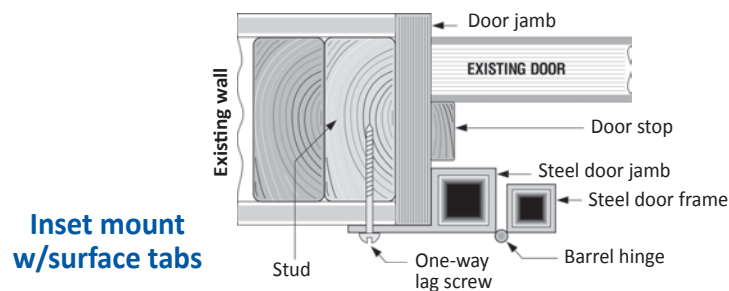

Inset mount w/surface tabs

Steel Storm Door Quick Fax Form

Fax to (909) 379-0169

Customer Name/ Acct. # _____ Customer Phone # _____

Contact Name _____ Customer Fax # _____

PO # / Job / Customer Name: _____ **QUOTE ONLY** **ORDER**

Qty	Door Name	Door Color	Background Color	Net Door Size (Includes Pre-Hung Frame)	Hinge Side	Handle Height	Notes & Options Instructions

**Note: Special handle placement is available for precision steel security doors. Hinge and handle side is always as viewed from outside!!*

SECTION 7 / GRILLES & ACCESSORIES

PRODUCT	PAGE
Swinging grilles.....	88
Sliding grilles.....	89
Custom swinging & sliding grille.....	90

SWINGING SCREEN DOOR GRILLES

Color code chart (xx)	
AD = Adobe	ML = Mill
AL = Almond	WH = White
BZ = Bronze	

FIESTA 27" (.090 thick pattern)

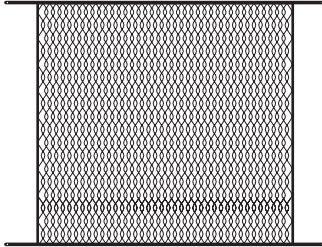

Part No.	Product Line	Description
2380xx	F3316	30" Swinging door grille
2381xx	F3316	32" Swinging door grille
2382xx	F3316	36" Swinging door grille
2383xx	F3316	42" Swinging door grille

EMPRESS 27" (.125 thick pattern)

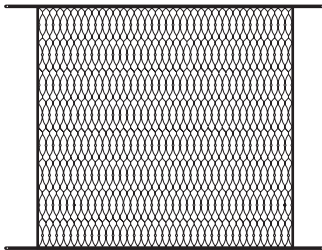

Part No.	Product Line	Description
2390xx	F3316	30" Swinging door grille
2391xx	F3316	32" Swinging door grille
2392xx	F3316	36" Swinging door grille
2393xx	F3316	42" Swinging door grille

SWINGING DOOR GRILLE NET SIZES

For Fiesta & Empress grilles

Nominal size	Actual tip to tip	Actual body size
30" x 27"	29"	25" x 27-1/4"
32" x 27"	31"	27" x 27-1/4"
36" x 27"	35"	31" x 27-1/4"
42" x 27"	41"	37" x 27-1/4"

SLIDING SCREEN DOOR GRILLES

Color code chart (xx)	
AD = Adobe	ML = Mill
AL = Almond	WH = White
BZ = Bronze	

FIESTA 33" (.090 thick pattern)

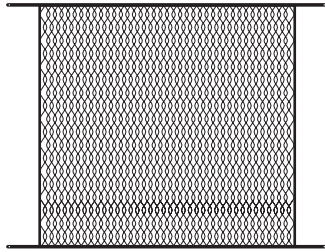

Part No.	Product Line	Description
2384xx	F3316	30" Sliding door grille
2385xx	F3316	36" Sliding door grille
2386xx	F3316	42" Sliding door grille
2387xx	F3316	48" Sliding door grille
2388xx	F3316	60" Sliding door grille

EMPRESS 33" (.125 thick pattern)

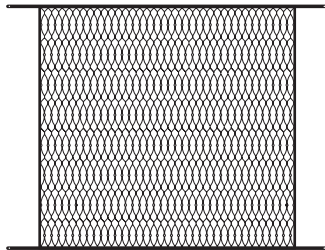

Part No.	Product Line	Description
2394xx	F3316	30" Sliding door grille
2395xx	F3316	36" Sliding door grille
2397xx	F3316	48" Sliding door grille
2398xx	F3316	60" Sliding door grille

SLIDING DOOR GRILLE NET SIZES

For Fiesta & Empress grilles

Nominal size	Actual tip to tip	Actual body size
30" x 33"	30"	26" x 33-1/8"
36" x 33"	36"	32" x 33-1/8"
48" x 33"	48"	44" x 33-1/8"
60" x 33"	60"	56" x 33-1/8"

CUSTOM MADE DOOR GRILLES

Color code chart (xx)	
AD = Adobe	ML = Mill
AL = Almond	WH = White
BZ = Bronze	

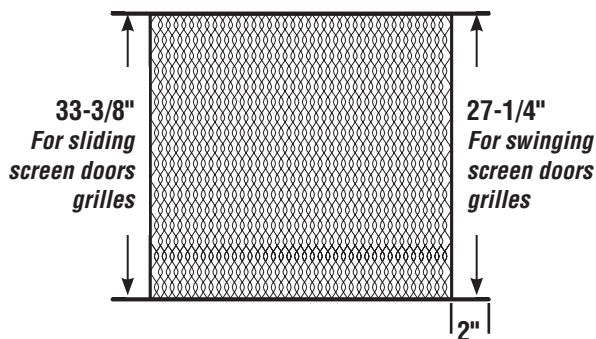

FIESTA (.090 thick pattern)

Part No.	Product Line	Description	
		Tip To Tip	No Tips
2389xx	F3316	To 34" x 27"	To 31" x 27"
2389xx	F3316	To 36" x 33"	To 32" x 33"
2389xx	F3316	To 48" x 33"	To 44" x 33"
2389xx	F3316	To 60" x 33"	To 56" x 33"

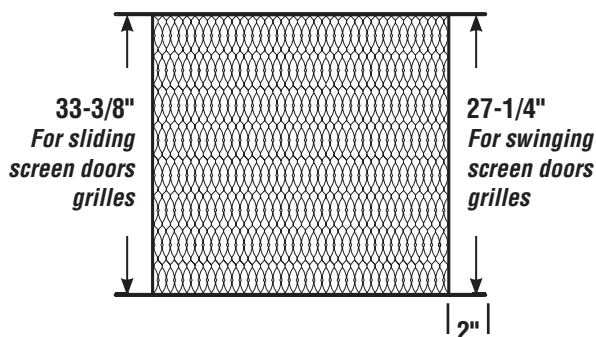

EMPRESS (.125 thick pattern)

Part No.	Product Line	Description	
		Tip To Tip	No Tips
2399xx	F3316	To 34" x 27"	To 31" x 27"
2399xx	F3316	To 36" x 33"	To 32" x 33"
2399xx	F3316	To 48" x 33"	To 44" x 33"
2399xx	F3316	To 60" x 33"	To 56" x 33"

SECTION 8 / PET ACCESSORIES

PRODUCT	PAGE
Measuring & installation information	91-93
Pet doors, adapters, panels & accessories	94

PRIDE PET DOOR HELPFUL HINTS

(PLEASE READ THIS BEFORE INSTALLING YOUR PET DOOR)



MAKING SURE YOU HAVE THE RIGHT SIZE PET DOOR

The opening of your pet door should be 1/2 inch wider than the width of your pet's shoulder. If you have more than one pet, the door should be wide enough for the largest pet, but should be mounted low enough so the smallest pet can get through it easily. However, it is not a good idea to buy a pet door larger than your pet actually needs. Too large an opening leads to over zealous behavior and money spent on spare parts.

HINT: A quick and easy way to determine if the pet door is the correct size for your pet is to open your sliding glass or other house door so that the door opening is the same as the width of the pet door flap, then see if your pet can pass easily through the space. Don't worry about the height, since the pet door will be mounted according to the height of your pet.

You can use the list below to determine which Pride Pet Door model is best for your pet:

MODEL SIZE OF PET

- | | |
|----------------|---|
| SD-300 | For cats or toy breeds up to 4 inches across shoulders |
| MD-400 | For Beagles and Poodles, or pets up to 8 inches across shoulders. |
| LD-500 | For German Shepherds and Boxers, or pets up to 11 inches across shoulders. |
| XLD-600 | For Great Danes and St. Bernards, or pets up to 14 inches across shoulders. |

DETERMINING THE LOCATION OF YOUR PET DOOR

Your pet door can be mounted in any location where there is a surface large enough to place the frames. Some important considerations are the following:

- 1. MOUNTING HEIGHT:** Bring your pet(s) to the place where you plan to install the pet door. On the surface where pet door will be mounted, make a mark to show the height of the pet's shoulders, and another mark to show the bottom of the pet's chest. Using these marks as a guide, place your pet door so that the pet does not have to stoop or jump to go through the pet door.
- 2. LOCATION ON A HOUSE DOOR:** If you are installing the pet door on a house door, it is a good idea to locate the pet door off-center, away from the house door handle or knob. This makes it more difficult for someone to unlock the house door by reaching in through the pet door. For your security, it is recommended that a deadbolt lock be added to any house door into which a pet door is installed. Also, any gates leading to an area with a pet door should be locked.

TEACHING YOUR PET TO USE THE PRIDE PET DOOR

With just a little help from you, your pet can quickly learn to use the pet door. Lift the flap slightly and coax the pet to come through a few times. Give him lots of praise when he comes through. If the pet is resistant, a treat or his favorite food can be useful. If your pet is highly resistant, you can tie up or remove the U-frame portion of the rubber assembly until the pet feels comfortable using the pet door. Then you can put the U-frame in its original position. Never push the pet through the opening as he may become frightened and continue to resist efforts to teach him to use the door.

PRIDE PET PANEL

- Easy entry & exit for your pets, allows complete freedom
- No more endless-trips to let pets in or out—leaving doors open
- Helps prevent troublesome household accidents
- No more scratched doors

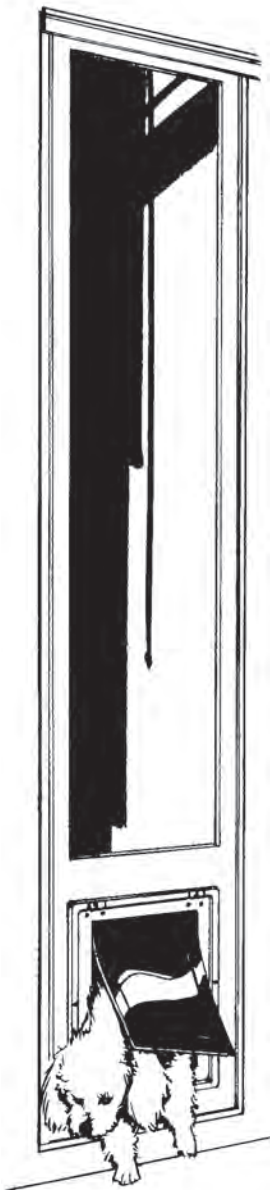

- Easily installed or removed with no special tools
- Designed for left or right hand sliding doors
- No holes to cut or alterations to make
- Pet door can be removed from pet panel for standard installation in wood door if desired
- Full use of sliding glass or green doors not affected
- Suitable for apartment use
- Blends with your natural architecture

PERMANENT INSTALLATIONS

Insert pet panel into sliding glass or sliding door track. (Glass door track makes for better installations). Determine if top, bottom, or both adjustment channels are required.

1. Push adjustment channels on pet panel as far as possible. Place pet panel, with adjustment channels on both ends, in sliding door jamb. Close sliding door against pet panel for a flush, firm fit.
2. Extend adjustment channels evenly allowing the pet panel to completely fill the available height area. Never extend adjustment channels so that there is less than 1/2" remaining on pet panel.
3. Each adjustment channel should be attached to the pet panel by drilling (3)-1/8" holes on the inside of the pet panel and insert the #8 x 1/2" Phillips pan head screws, be sure screws adjustment channel do not interfere with the glass door surrounding-frame.
4. Secure pet panel to surrounding frame by drilling through frame and into the pet panel. Drill (3) 1/8" holes at both top & bottom of pet panel and 3 along side of pet panel. Insert #8 x 1/2" Phillips pan head screws.

TEMPORARY INSTALLATIONS

1. Secure adjustment channels in the same manner as permanent installation provides, however, adjustment channels should be placed so that the panel can be removed with ease from the track. Adjustment channels therefore should not be extended to fill full height of the opening.
2. Attach rubber bumpers both top & bottom and on both sides of the pet panel, if required, to make for tight fit in door jamb.

YOUR PET AND THE NEW PRIDE PET PANEL

In the design and manufacture of the pride pet panel, effort has been made to produce a two way door that your pet can operate with complete confidence.

Most animals will learn to use the pet panel in a matter of minutes, with a help from the owner. In introducing the dog or cat to the pet panel, lift up the flap a few inches, coax him through a few times. The first times he goes through "on his own" he has graduated.

If you selected the Deluxe Series pet panel, you may deny the use of the door to your pet by inserting the closing panel on pet's side of the door. He will then see a solid door and will not attempt to use it. With this installation your pet now has the same "come and go" freedom that his master enjoys.

Manufactured under
U.S. Patent Numbers
3,464,158

PRIDE PET PANEL

If you want your pet to come in through a sliding glass door, here's the perfect answer!!!

- Sturdy extruded aluminum
- Adobe, black, bronze, satin aluminum, tan or white
- Clear or obscure tempered glass
- Left or right sliding doors
- Full length weather-stripping
- Top and bottom adjustments
- Security locking device
- Fits opening 78-1/2" to 81" (not over 81")
- No special tools required
- No holes or alterations (single glazed only)

SLIDING DOOR PET PANEL SPECIFICATIONS

Description	Small	Medium	Large
Flap size	4-3/4" x 7-1/8"	8-1/2" x 12-1/2"	11-1/2" x 16-7/8"
Overall size	10-5/8" x 78-1/4"	14-1/4" x 78-1/4"	17-1/8" x 78-1/4"

DELUXE DOOR SPECIFICATIONS

Description	Small	Medium	Large
Pet opening	4-7/8" x 7-7/16"	8-1/2" x 12-5/8"	11-3/8" x 16-13/16"
Rough opening size	7-9/16" x 9-5/8"	11-1/8" x 14-7/8"	14" x 18-7/8"
Overall size	9-1/8" x 12-1/2"	12-5/8" x 15-3/4"	15-1/2" x 18-7/8"

SLIDING SCREEN DELUXE PET DOOR ADAPTER

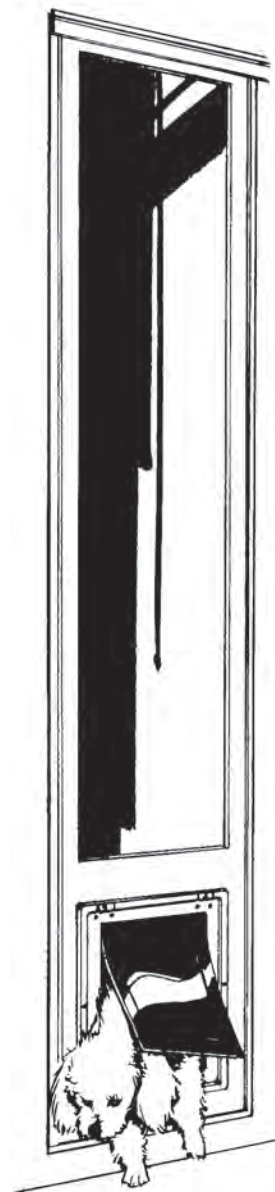
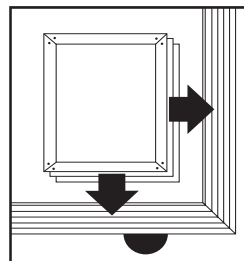

- To keep your pet from entering or leaving, security panel slides into either outside or inside frame of deluxe model pride pet doors.
- Adapters are available for small, medium, large and x-large deluxe pet doors.

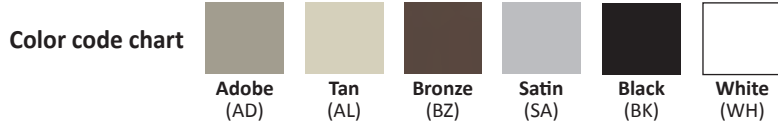

Manufactured under
U.S. Patent Numbers
3,464,158

PET ACCESSORIES

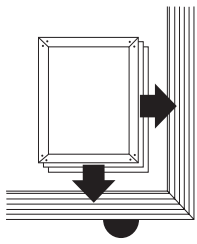
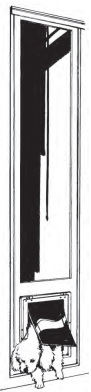

	Part No.	Product Line	Description
	2186BZ	F3900	The original pet screen door (8" x 10") Bronze plastic
	2187R 2188R 2189R 2190R	F3900 F3900 F3900 F3900	2 Piece rubber replacement assembly (Black) For small pet door For medium pet door For large pet door For X-large pet door
	2187xx 2188xx 2189xx 2190xx	F3900 F3900 F3900 F3900	Pride deluxe pet door 5" x 7-1/8" small 8-1/2" x 12-1/2" medium 11-1/2" x 16-7/8" large 14-1/2" x 19-1/2" X-large <i>See color code chart for available colors</i>
	2203xx 2204xx 2205xx 2206xx	F3900 F3900 F3900 F3900	Deluxe pet adapter Small Medium Large X-Large <i>See color code chart for available colors</i>
	2193xx 2194xx 2195xx	F3900 F3900 F3900	Pride pet panel Small (6'8") Medium (6'8") Large (6'8") <i>See color code chart for available colors</i>

Precision will custom install pet doors into your new screen door. See appropriate door section for options

SECTION 9 / SCREEN CLOTH ROLL GOODS & SPLINE

PRODUCT	PAGE
Fiberglass screening – 18 x 14 and 18 x 16 <i>Better vue, ultra vue</i>	96
Aluminum / stainless steel screening <i>See vue</i>	97
Sun control products <i>Sunscreen, solar insect, suntex, super solar</i>	97-98
Specialty screen products <i>Petscreen, glassine, aluminum grille cloth, tuff screen</i>	98
Screen retainer spline	99
Order form	100

FIBERGLASS SCREEN ROLL GOODS

FIBERGLASS SCREENING 18 X 16 MESH

Charcoal & Gray (Product Line: B2000)

Charcoal (CFxx)	Gray (FGxx)	Description	Sq. Ft. Per 100' Roll
CF18	FG18	18" Fiberglass	150
CF20	FG20	20" Fiberglass	167
CF22	FG22	22" Fiberglass	183
CF24	FG24	24" Fiberglass	200
CF26	FG26	26" Fiberglass	217
CF28	FG28	28" Fiberglass	233
CF30	FG30	30" Fiberglass	250
CF32	FG32	32" Fiberglass	267
CF34	FG34	34" Fiberglass	283
CF36	FG36	36" Fiberglass	300
CF38	FG38	38" Fiberglass	317
CF40	FG40	40" Fiberglass	333
CF42	FG42	42" Fiberglass	350
CF44	FG44	44" Fiberglass	366
CF46	FG46	46" Fiberglass	382
CF48	FG48	48" Fiberglass	400
CF54	FG54	54" Fiberglass	450
CF60	FG60	60" Fiberglass	500
CF72	FG72	72" Fiberglass	600
CF84	FG84	84" Fiberglass	700

FIBERGLASS SCREENING 18 X 16 MESH ROM

Charcoal & Gray (Product Line: B2002)

Charcoal (CFLxx)	Gray (GFLxx)	Description	Sq. Ft. Per 600' Roll
CFL18	GFL18	18" Fiberglass ROM	900
CFL24	GFL24	24" Fiberglass ROM	1200
CFL30	GFL30	30" Fiberglass ROM	1500
CFL32	GFL32	32" Fiberglass ROM	1600
CFL36	GFL36	36" Fiberglass ROM	1800
CFL42	GFL42	42" Fiberglass ROM	2100
CFL48	GFL48	48" Fiberglass ROM	2400
CFL60	GFL60	60" Fiberglass ROM	3000
CFL72	GFL72	72" Fiberglass ROM	3600

BETTER VUE FIBERGLASS SCREENING MESH

Charcoal (Product Line: B2000)

Charcoal (BVxx)	Description	Sq. Ft. Per 100' Roll
BV24	24" Fiberglass	200
BV30	30" Fiberglass	250
BV36	36" Fiberglass	300
BV48	48" Fiberglass	400
BV60	60" Fiberglass	500
BV72	72" Fiberglass	600

BETTER VUE FIBERGLASS SCREENING MESH ROM

Charcoal (Product Line: B2000)

Charcoal (BVLxx)	Description	Sq. Ft. Per 600' Roll
BVL30	30" Fiberglass	1500
BVL36	36" Fiberglass	1800
BVL48	48" Fiberglass	2400
BVL60	60" Fiberglass	3000

ULTRA VUE FIBERGLASS SCREENING MESH

Charcoal (Product Line: B2000)

Charcoal (UVxx)	Description	Sq. Ft. Per 100' Roll
UV24	24" Fiberglass ROM	200
UV36	36" Fiberglass ROM	300
UV48	48" Fiberglass ROM	400
UV60	60" Fiberglass ROM	500
UV72	72" Fiberglass ROM	600

FIBERGLASS SCREENING 18 X 14 MESH

Charcoal & Gray (Product Line: B2001)

Charcoal (CFHxx)	Gray (FGHxx)	Description	Sq. Ft. Per 100' Roll
CFH18	FGH18	18" Fiberglass	150
CFH24	FGH24	24" Fiberglass	200
CFH30	FGH30	30" Fiberglass	250
CFH32	FGH32	32" Fiberglass	267
CFH36	FGH36	36" Fiberglass	300
CFH42	FGH42	42" Fiberglass	350
CFH48	FGH48	48" Fiberglass	400
CFH54	FGH54	54" Fiberglass	450
CFH60	FGH60	60" Fiberglass	500
CFH72	FGH72	72" Fiberglass	600
CFH84	FGH84	84" Fiberglass	700
CFH96	FGH96	96" Fiberglass	800
CFH108	FGH108	108" Fiberglass	900

ALUMINUM SCREEN ROLL GOODS

ALUMINUM SCREENING 18 X 16 MESH

Silver (Product Line: B2003)

Silver (ALxx)	Description	Sq. Ft. Per 100' Roll
AL18	18" Aluminum	150
AL20	20" Aluminum	167
AL22	22" Aluminum	183
AL24	24" Aluminum	200
AL26	26" Aluminum	217
AL28	28" Aluminum	233
AL30	30" Aluminum	250
AL32	32" Aluminum	267
AL34	34" Aluminum	283
AL36	36" Aluminum	300
AL38	38" Aluminum	317
AL40	40" Aluminum	333
AL42	42" Aluminum	350
AL44	44" Aluminum	366
AL48	48" Aluminum	400
AL54	54" Aluminum	450
AL60	60" Aluminum	500
AL72	72" Aluminum	600

ALUMINUM SCREENING 18 X 16 MESH

Charcoal & Black (Product Line: B2003)

Charcoal (CAxx)	Black (BAxxBK)	Description	Sq. Ft. Per 100' Roll
CA18	BA18BK	18" Aluminum	150
CA20	BA20BK	20" Aluminum	167
CA22	BA22BK	22" Aluminum	183
CA24	BA24BK	24" Aluminum	200
CA26	BA26BK	26" Aluminum	217
CA28	—	28" Aluminum	233
CA30	BA30BK	30" Aluminum	250
CA32	BA32BK	32" Aluminum	267
CA34	BA34BK	34" Aluminum	283
CA36	BA36BK	36" Aluminum	300
CA38	—	38" Aluminum	317
CA40	BA40BK	40" Aluminum	333
CA42	BA42BK	42" Aluminum	350
CA48	BA48BK	48" Aluminum	400
CA60	BA60BK	60" Aluminum	500
CA72	BA72BK	72" Aluminum	600

STAINLESS STEEL SCREENING 18 X 16 MESH

(Product Line: B2000)

Stainless Steel (SVxx)	Description	Sq. Ft. Per 50' Roll
SV36	36" See vue stainless steel wire cloth	150
SV48	48" See vue stainless steel wire cloth	200

SUN CONTROL SCREEN ROLL GOODS

PHIFER SUN SCREEN

Charcoal & Gray – 70% Block (Product Line: B2006)

Charcoal (SCCxx)	Gray (SCGxx)	Description	Sq. Ft. Per 100' Roll
SCC24	SCG24	24" Sun screen	200
SCC30	SCG30	30" Sun screen	250
SCC36	SCG36	36" Sun screen	300
SCC42	SCG42	42" Sun screen	350
SCC48	SCG48	48" Sun screen	400
SCC60	SCG60	60" Sun screen	500
SCC72	SCG72	72" Sun screen	600
SCC84	SCG84	84" Sun screen	700

FIBERGLASS SCREENING 20 X 20 MESH

Charcoal (Product Line: B2006)

Charcoal (TTBxx)	Description	Sq. Ft. Per 100' Roll
TTB36	36" Fiberglass	300
TTB48	48" Fiberglass	400
TTB60	60" Fiberglass	500

SOLAR INSECT 20 X 30

Charcoal & Gray – 65% Block (Product Line: B2006)

Charcoal (TWBxx)	Gray (TWGxx)	Description	Sq. Ft. Per 100' Roll
TWB24	TWG24	24" Sun control	200
TWB30	TWG30	30" Sun control	250
TWB36	TWG36	36" Sun control	300
TWB48	TWG48	48" Sun control	400
TWB60	TWG60	60" Sun control	500
TWB72	TWG72	72" Sun control	600
TWB84	TWG84	84" Sun control	700

SUPER SOLAR

Charcoal & Gray – 90% Block (Product Line: B2006)

Charcoal (SSCxx)	Gray (SSGxx)	Description	Sq. Ft. Per 100' Roll
SSC36	SSG36	36" Phifer super solar screen	300
SSC48	SSG48	48" Phifer super solar screen	400
SSC60	SSG60	60" Phifer super solar screen	500
SSC84	SSG84	84" Phifer super solar screen	700

SUN CONTROL SCREEN ROLL GOODS

SUN TEX 80

Bronze, Black, Brown, Stucco & Gray – 80% Block (Product Line: B2005)

Bronze (STRxx)	Black (STBKxx)	Brown (STNxx)	Stucco (STSxx)	Gray (STGxx)	Description	Sq. Ft. Per 100' Roll
STR36	STBK36	STN36	STS36	STG36	36" Sun tex	300
STR48	STBK48	STN48	STS48	STG48	48" Sun tex	400
STR60	STBK60	STN60	STS60	STG60	60" Sun tex	500
STR72	STBK72	STN72	STS72	STG72	72" Sun tex	600
STR96	STBK96	STN96	STS96	STG96	96" Sun tex	800

SUN TEX 90

Bronze, Black, Brown, Stucco & Gray – 90% Block (Product Line: B2005)

Bronze (SXRxx)	Black (SXBKxx)	Brown (SXXNxx)	Stucco (SXSxx)	Gray (SXGxx)	Description	Sq. Ft. Per 100' Roll
SXR36	SXBK36	SXXN36	SXS36	SXG36	36" Sun tex	300
SXR48	SXBK48	SXXN48	SXS48	SXG48	48" Sun tex	400
SXR60	SXBK60	SXXN60	SXS60	SXG60	60" Sun tex	500
SXR72	SXBK72	SXXN72	SXS72	SXG72	72" Sun tex	600
SXR96	SXBK96	SXXN96	SXS96	SXG96	96" Sun tex	800

SPECIALTY SCREEN ROLL GOODS

PET SCREEN

Black & Gray (Product Line: B2006)

Charcoal (PSBKxx)	Gray (PSGxx)	Description	Sq. Ft. Per 100' Roll
PSBK36	PSG36	36" Pet screen	300
PSBK48	PSG48	48" Pet screen	400
PSBK60	PSG60	60" Pet screen	500

ALUMINUM GRILLE CLOTH

Silver (Product Line: B2008)

Black (GCxx)	Description	Sq. Ft. Per 50' Roll
GC36	36" Aluminum grille cloth	150
GC48	48" Aluminum grille cloth	200

TUFF SCREEN

Black (Product Line: B2006)

Black (TPSBKxx)	Description	Sq. Ft. Per 100' Roll
TPSBK36	36" Pet screen lite	300
TPSBK48	48" Pet screen lite	400
TPSBK60	60" Pet screen lite	500
TPSBK96	96" Pet screen lite	800

GLASSINE

(Product Line: B2008)

.012 Ga. (GLxx)	Description	Yards Per Roll
GL36	36" Clear glassine	70
GL48	48" Clear glassine	52
GL54	54" Clear glassine	47

.015 Ga. (GHxx)	Description	Yards Per Roll
GH36	36" Clear glassine	60
GH48	48" Clear glassine	45
GH54	54" Clear glassine	40









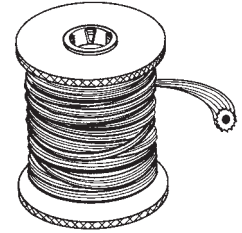













SCREEN RETAINER SPLINE

For aluminum and fiberglass screening

SERRATED SPLINE

Description: Top quality vinyl, round, hollow core, serrated.



Actual Size	Size/Decimal
	.120 - 1/8"
	.130
	.135
	.140 - 9/64"
	.150
	.155 - 5/32"
	.165 - 11/64"
	.170
	.175
	.180
	.185 - 3/16"
	.190
	.195
	.200 - 13/64"
	.210 - 7/32"
	.215
	.220
	.225
	.230
	.235
	.250 - 1/4"
	.260

Bulk 15 lbs. – 1 Roll per box		Approx. Ft./15 Lb. Roll
Black	Gray	
Product Line: A1410		
187BK.100	N/A	
187BK.120	187GR.120	2670
187BK.125	187GR.125	
187BK.130	N/A	2400
187BK.135	187GR.135	2190
187BK.140	N/A	1920
187BK.145	N/A	1875
187BK.150	187GR.150	1815
187BK.155	N/A	1710
187BK.160	187GR.160	1600
187BK.165	187GR.165	1500
187BK.170	187GR.170	1400
187BK.175	187GR.175	1320
187BK.180	187GR.180	1200
187BK.185	187GR.185	1140
187BK.190	187GR.190	1095
187BK.195	187GR.195	1005
187BK.200	187GR.200	990
187BK.205	N/A	950
187BK.210	187GR.210	915
187BK.215	187GR.215	865
187BK.220	187GR.220	855
187BK.225	187GR.225	800
187BK.230	187GR.230	780
187BK.235	187GR.235	750
187BK.240	187GR.240	715
187BK.245	187GR.245	675
187BK.250	187GR.250	660
187BK.255	N/A	655
187BK.260	187GR.260	645

SMOOTH SPLINE

(Product Line: A1410)

Black	Approx. Ft./15 Lb. Roll
187BKA.180	700
187BKA.230	475
187BKA.235	400

ROLL GOODS & SPLINE ORDER FORM

PRECISION



26950 San Bernardino Avenue, Redlands, CA 92374

Date		P.O. No.		Placed By		Taken By		Phone No.		Acct. No.	
Bill To						Ship To					
Address						Address					
City		State		Zip		City		State		Zip	
Ship Via		<input type="checkbox"/> U.P.S./R.P.S.		<input type="checkbox"/> _____		Ship Date				Approved By	
Freight Prepaid & Charge		<input type="checkbox"/>		<input type="checkbox"/> C.O.D.		B.O. From Inv. No.				Fax No.	
	Order Qty	Description	Price	Comments		Order Qty	Description	Price	Comments		
1					27						
2					28						
3					29						
4					30						
5					31						
6					32						
7					33						
8					34						
8					35						
10					36						
11					37						
12					38						
13					39						
14					40						
15					41						
16					42						
17					43						
18					44						
19					45						
20					46						
21					47						
22					48						
23					49						
24					50						
25					51						
26					52						
		Qty./Roll Total				Qty./Roll Total					

SECTION 10 / WINDOW SCREEN FRAME & COMPONENTS

PRODUCT	PAGE
Screen frame w/corners (1/4" thru 1-1/4").....	102-107
Lip & stand-off screen frame w/corners.....	108
Spreader bar & clips	109
Screen slide channels, mullion & screen circles	110
Adjustable corners, wickets (plastic & metal).....	111
Die-cast screen clips	112
Plastic screen clips.....	112
Casement clips	112
Retainer clips & pull tabs.....	113
Screen tension springs (flat & corner mount) & screen hangers.....	113
Jiffy hangers & bail latches	114
Plunger latches & slide locks	114
Screen frame order guide.....	115

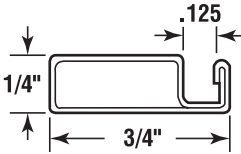
1/4" ALUMINUM SCREEN FRAME & CORNERS

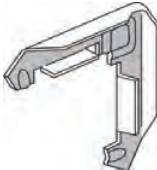
SER-123	Part No.	Length	Pcs/Carton	Ft./Carton	Thickness	Finish
3/4" x 1/4" Screen frame  Use spline size: .135 (Aluminum mesh) .150 (Fiberglass mesh)	123ML122-BX	12'2"	90	1095'	.020	Mill/Unpainted
	123BZ122-BX	12'2"	90	1095'	.020	Bronze
	123WH122-BX	12'2"	90	1095'	.020	White
	Part No.	Length	Pcs/Bundle	Ft./Bundle	Thickness	Finish
	123ML122-BN	12'2"	50	608'	.020	Mill/Unpainted
	123BZ122-BN	12'2"	50	608'	.020	Bronze
	123WH122-BN	12'2"	50	608'	.020	White
	123ML122-PK	12'2"	10	122'	.020	Mill/Unpainted
	123BZ122-PK	12'2"	10	122'	.020	Bronze
	123WH122-PK	12'2"	10	122'	.020	White
Part No.	Pcs/Bag	Pcs/Carton	Finish			
3/4" x 1/4" Plastic corner 	C123GR	100	1000	Gray		
	C123BZ	100	1000	Bronze		
	C123WH	100	1000	White		
Part No.	Pcs/Bag	Pcs/Carton	Thickness	Finish		
3/4" x 1/4" Miter cut corner 	C123ML-035	100	1000	.035	Mill/Unpainted	

NOTE:

50 piece bundles and 10 piece poly bagged packs available on most lineal items
 Less than pack quantities available on selected items only
 Screen corners now available in 100 piece poly bags

5/16" ALUMINUM SCREEN FRAME & CORNERS

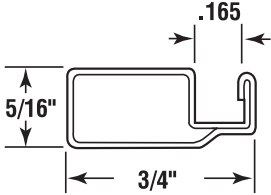
SER-520	Part No.	Length	Pcs/Carton	Ft./Carton	Thickness	Finish
<p>3/4" x 5/16" Screen frame</p>  <p>Use spline size: .165 (Aluminum mesh) .185 (Fiberglass mesh)</p>	520ML122-BX	12'2"	100	1217'	.020	Mill/Unpainted
	520GR122-BX	12'2"	100	1217'	.020	Gray
	520BZ122-BX	12'2"	100	1217'	.020	Bronze
	520WH122-BX	12'2"	100	1217'	.020	White
	520AL122-BX	12'2"	100	1217'	.020	Almond
	520AD122-BX	12'2"	100	1217'	.020	Adobe
	Part No.	Length	Pcs/Bundle	Ft./Bundle	Thickness	Finish
	520ML122-BN	12'2"	50	608'	.020	Mill/Unpainted
	520GR122-BN	12'2"	50	608'	.020	Gray
	520BZ122-BN	12'2"	50	608'	.020	Bronze
	520WH122-BN	12'2"	50	608'	.020	White
	520AL122-BN	12'2"	50	608'	.020	Almond
	520AD122-BN	12'2"	50	608'	.020	Adobe
520ML122-PK	12'2"	10	122'	.020	Mill/Unpainted	
520GR122-PK	12'2"	10	122'	.020	Gray	
520BZ122-PK	12'2"	10	122'	.020	Bronze	
520WH122-PK	12'2"	10	122'	.020	White	
520AL122-PK	12'2"	10	122'	.020	Almond	
520AD122-PK	12'2"	10	122'	.020	Adobe	
Part No.	Pcs/Bag	Pcs/Carton	Finish			
3/4" x 5/16" Plastic corner	C520GR	100	1000	Gray		
	C520BZ	100	1000	Bronze		
	C520WH	100	1000	White		
Part No.	Pcs/Bag	Pcs/Carton	Thickness	Finish		
3/4" x 5/16" Miter cut corner	C520ML-040	100	1000	.040	Mill/Unpainted	

NOTE:

50 piece bundles and 10 piece poly bagged packs available on most lineal items
 Less than pack quantities available on selected items only
 Screen corners now available in 100 piece poly bags

3/8" ALUMINUM SCREEN FRAME & CORNERS

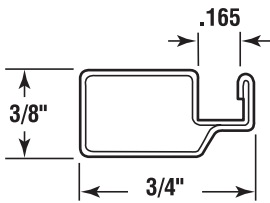

SER-519	Part No.	Length	Pcs/Carton	Ft./Carton	Thickness	Finish
<p>3/4" x 3/8" Screen frame</p>  <p>SER-119 = .020 SER-119E = .018 SER-119H = .025</p> <p>Use spline size: .165 (Aluminum mesh) .185 (Fiberglass mesh)</p>	519ML122-BX	12'2"	100	1217'	.020	Mill/Unpainted
	519GR122-BX	12'2"	100	1217'	.020	Gray
	519BZ122-BX	12'2"	100	1217'	.020	Bronze
	519WH122-BX	12'2"	100	1217'	.020	White
	519AL122-BX	12'2"	100	1217'	.020	Almond
	519AD122-BX	12'2"	100	1217'	.020	Adobe
	Part No.	Length	Pcs/Bundle	Ft./Bundle	Thickness	Finish
	519ML122-BN	12'2"	50	608'	.020	Mill/Unpainted
	519GR122-BN	12'2"	50	608'	.020	Gray
	519BZ122-BN	12'2"	50	608'	.020	Bronze
	519WH122-BN	12'2"	50	608'	.020	White
	519AL122-BN	12'2"	50	608'	.020	Almond
	519AD122-BN	12'2"	50	608'	.020	Adobe
	519ML122-PK	12'2"	10	122'	.020	Mill/Unpainted
	519GR122-PK	12'2"	10	122'	.020	Gray
	519BZ122-PK	12'2"	10	122'	.020	Bronze
	519WH122-PK	12'2"	10	122'	.020	White
	519AL122-PK	12'2"	10	122'	.020	Almond
	519AD122-PK	12'2"	10	122'	.020	Adobe
	Part No.	Length	Pcs/Carton	Ft./Carton	Thickness	Finish
	519ML122H-BX	12'2"	100	1217'	.025	Mill/Unpainted
	519GR122H-BX	12'2"	100	1217'	.025	Gray
	519BZ122H-BX	12'2"	100	1217'	.025	Bronze
	519WH122H-B	12'2"	100	1217'	.025	White
	Part No.	Length	Pcs/Bundle	Ft./Bundle	Thickness	Finish
	519ML122H-BN	12'2"	50	608'	.025	Mill/Unpainted
	519GR122H-BN	12'2"	50	608'	.025	Gray
	519BZ122H-BN	12'2"	50	608'	.025	Bronze
519WH122H-BN	12'2"	50	608'	.025	White	
519ML122H-PK	12'2"	10	122'	.025	Mill/Unpainted	
519GR122H-PK	12'2"	10	122'	.025	Gray	
519BZ122H-PK	12'2"	10	122'	.025	Bronze	
519WH122H-PK	12'2"	10	122'	.025	White	
Part No.	Length	Pcs/Bag	Pcs/Carton	Thickness	Finish	
3/4" x 3/8" Plastic corner	C119GR		100		Gray	
	C119BZ		100		Bronze	
	C119WH		100		White	
	C119AL		100		Almond	
Part No.	Length	Pcs/Bag	Pcs/Carton	Thickness	Finish	
3/4" x 3/8" Miter cut corner	C519ML-050		100	1000	.050	Mill/Unpainted

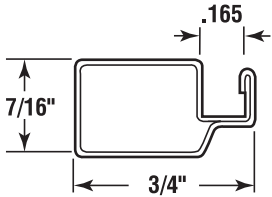
7/16" ALUMINUM SCREEN FRAME & CORNERS

SER-516	Part No.	Length	Pcs/Carton	Ft./Carton	Thickness	Finish
<p>3/4" x 7/16" Screen frame</p>  <p>SER-115 = .025 SER-116 = .020 SER-116E = .018</p> <p>Use spline size: .165 (Aluminum mesh) .185 (Fiberglass mesh)</p>	516ML122-BX	12'2"	100	1217'	.020	Mill/Unpainted
	516GR122-BX	12'2"	100	1217'	.020	Gray
	516BZ122-BX	12'2"	100	1217'	.020	Bronze
	516WH122-BX	12'2"	100	1217'	.020	White
	516AL122-BX	12'2"	100	1217'	.020	Almond
	516AD122-BX	12'2"	100	1217'	.020	Adobe
	Part No.	Length	Pcs/Bundle	Ft./Bundle	Thickness	Finish
	516ML122-BN	12'2"	50	608'	.020	Mill/Unpainted
	516GR122-BN	12'2"	50	608'	.020	Gray
	516BZ122-BN	12'2"	50	608'	.020	Bronze
	516WH122-BN	12'2"	50	608'	.020	White
	516AL122-BN	12'2"	50	608'	.020	Almond
	516AD122-BN	12'2"	50	608'	.020	Adobe
	516ML122-PK	12'2"	10	122'	.020	Mill/Unpainted
	516GR122-PK	12'2"	10	122'	.020	Gray
	516BZ122-PK	12'2"	10	122'	.020	Bronze
	516WH122-PK	12'2"	10	122'	.020	White
	516AL122-PK	12'2"	10	122'	.020	Almond
	516AD122-PK	12'2"	10	122'	.020	Adobe
	Part No.	Length	Pcs/Carton	Ft./Carton	Thickness	Finish
	515ML122-BX	12'2"	100	1217'	.025	Mill/Unpainted
	515GR122-BX	12'2"	100	1217'	.025	Gray
	515BZ122-BX	12'2"	100	1217'	.025	Bronze
	515WH122-BX	12'2"	100	1217'	.025	White
	Part No.	Length	Pcs/Bundle	Ft./Bundle	Thickness	Finish
	515ML122-BN	12'2"	50	608'	.025	Mill/Unpainted
	515GR122-BN	12'2"	50	608'	.025	Gray
	515BZ122-BN	12'2"	50	608'	.025	Bronze
515WH122-BN	12'2"	50	608'	.025	White	
515ML122-PK	12'2"	10	122'	.025	Mill/Unpainted	
515GR122-PK	12'2"	10	122'	.025	Gray	
515BZ122-PK	12'2"	10	122'	.025	Bronze	
515WH122-PK	12'2"	10	122'	.025	White	
Part No.	Pcs/Bag	Pcs/Carton	Thickness	Finish		
3/4" x 7/16" Plastic corner	C116GR	100	1000		Gray	
	C116BZ	100	1000		Bronze	
	C116WH	100	1000		White	
	C116AL	100	1000		Almond	
Part No.	Pcs/Bag	Pcs/Carton	Thickness	Finish		
3/4" x 7/16" Miter cut corner	C515ML-050	100	1000	.050	Mill/Unpainted	

1" ALUMINUM SCREEN FRAME & CORNERS

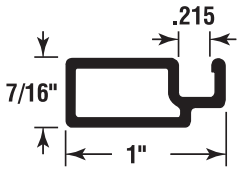
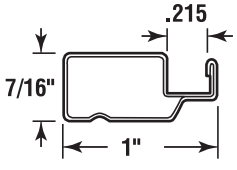
Item packs marked with "*"available in less than pack quantities

SER-114	Part No.	Length	Pcs/Carton	Ft./Carton	Thickness	Finish
<p>1" Extruded screen frame</p>  <p>Use spline size: .235 (Aluminum mesh) .250 (Fiberglass mesh) Use corner C114ML-040</p>	114ML122-BX	12'2"	50	608'	.050	Mill/Unpainted
	114SA122-BX	12'2"	50	608'	.050	Satin anodized
	114BZ122-BX	12'2"	50	608'	.050	Bronze
	114BA122-BX	12'2"	50	608'	.050	Bronze anodized
	114WH122-BX	12'2"	50	608'	.050	White
	114AL122-BX	12'2"	50	608'	.050	Almond
	Part No.	Length	Pcs/Bundle	Ft./Bundle	Thickness	Finish
	114ML122-PK	12'2"	10*	122'	.050	Mill/Unpainted
	114SA122-PK	12'2"	10*	122'	.050	Satin anodized
	114BZ122-PK	12'2"	10*	122'	.050	Bronze
	114BA122-PK	12'2"	10*	122'	.050	Bronze anodized
	114WH122-PK	12'2"	10*	122'	.050	White
	114AL122-PK	12'2"	10*	122'	.050	Almond
	SER-112	Part No.	Length	Pcs/Carton	Ft./Carton	Thickness
<p>1" Screen frame</p>  <p>SER-112 = .032 SER-513 = .025</p> <p>Use spline size: .235 (Aluminum mesh) .250 (Fiberglass mesh) Use corner C112ML-xxx</p>	112ML122-BX	12'2"	65	791'	.032	Mill/Unpainted
	112GR122-BX	12'2"	65	791'	.032	Gray
	112BZ122-BX	12'2"	65	791'	.032	Bronze
	112WH122-BX	12'2"	65	791'	.032	White
	Part No.	Length	Pcs/Bundle	Ft./Bundle	Thickness	Finish
	112ML122-PK	12'2"	10	122'	.032	Mill/Unpainted
	112GR122-PK	12'2"	10	122'	.032	Gray
	112BZ122-PK	12'2"	10	122'	.032	Bronze
	112WH122-PK	12'2"	10	122'	.032	White
	Part No.	Length	Pcs/Carton	Ft./Carton	Thickness	Finish
	513ML122-BX	12'2"	84	1022'	.025	Mill/Unpainted
	513GR122-BX	12'2"	84	1022'	.025	Gray
	513BZ122-BX	12'2"	84	1022'	.025	Bronze
	513WH122-BX	12'2"	84	1022'	.025	White
	513AL122-BX	12'2"	84	1022'	.025	Almond
	513AD122-BX	12'2"	84	1022'	.025	Adobe
	Part No.	Length	Pcs/Bundle	Ft./Bundle	Thickness	Finish
	513ML122-PK	12'2"	10	122'	.025	Mill/Unpainted
	513GR122-PK	12'2"	10	122'	.025	Gray
	513BZ122-PK	12'2"	10	122'	.025	Bronze
513WH122-PK	12'2"	10	122'	.025	White	
513AL122-PK	12'2"	10	122'	.025	Almond	
513AD122-PK	12'2"	10	122'	.025	Adobe	
Part No.	Length	Pcs/Bag	Pcs/Carton	Thickness	Finish	
<p>1" x 7/16" Miter cut corner</p> 	C112ML-050		100	1000	.050	Mill/Unpainted
	C112ML-060		100	1000	.060	Mill/Unpainted
	C114ML-040		100	1000	0.04	Mill/Unpainted
	C513ML-060		100	1000	0.06	Mill/Unpainted

1-1/4" ALUMINUM SCREEN FRAME & CORNERS

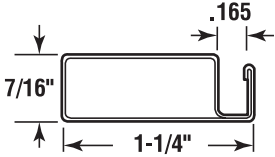
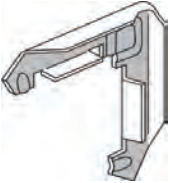
SER-111	Part No.	Length	Pcs/Carton	Ft./Carton	Thickness	Finish
1-1/4" x 7/16" Screen frame  Use spline size: .165 (Aluminum mesh) .185 (Fiberglass mesh) Use corner C111ML-060	111BZ122-BX	12'2"	65	791'	.040	Bronze
	Part No.	Length	Pcs/Bundle	Ft./Bundle	Thickness	Finish
	111BZ122-PK	12'2"	10	122'	.040	Bronze
Part No.		Pcs/Bag	Pcs/Carton	Thickness	Finish	
1-1/4" x 7/16" Miter cut corner	C111ML-060	100	1000	.060	Mill/Unpainted	
						

NOTE:

50 piece bundles and 10 piece poly bagged packs available on most lineal items
 Less than pack quantities available on selected items only
 Screen corners now available in 100 piece poly bags

LIP & STAND-OFF ALUMINUM SCREEN FRAME

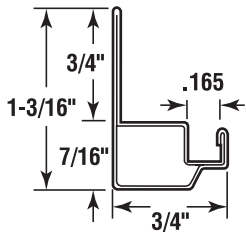
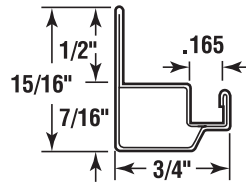
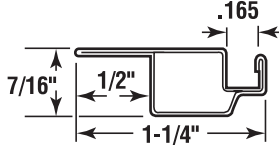
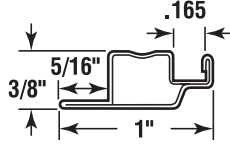
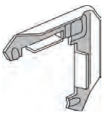
SER-124	Part No.	Length	Pcs/Carton	Ft./Carton	Thickness	Finish
3/4" Stand-off frame  Use corner C115ML-xxx	124ML122-BX	12'2"	60	730'	.025	Mill/Unpainted
	124GR122-BX	12'2"	60	730'	.025	Gray
	124BZ122-BX	12'2"	60	730'	.025	Bronze
	124WH122-BX	12'2"	60	730'	.025	White
	124AL122-BX	12'2"	60	730'	.025	Almond
	124AD122-BX	12'2"	60	730'	.025	Adobe
	Part No.	Length	Pcs/Bundle	Ft./Bundle	Thickness	Finish
	124ML122-PK	12'2"	10	122'	.025	Mill/Unpainted
	124GR122-PK	12'2"	10	122'	.025	Gray
	124BZ122-PK	12'2"	10	122'	.025	Bronze
	124WH122-PK	12'2"	10	122'	.025	White
	124AL122-PK	12'2"	10	122'	.025	Almond
	124AD122-PK	12'2"	10	122'	.025	Adobe
SER-129	Part No.	Length	Pcs/Carton	Ft./Carton	Thickness	Finish
1/2" Stand-off frame  Use corner C115ML-040 or AC115BK (adjustable)	129ML122-BX	12'2"	90	1095'	.025	Mill/Unpainted
	129GR122-BX	12'2"	90	1095'	.025	Gray
	129BZ122-BX	12'2"	90	1095'	.025	Bronze
	129WH122-BX	12'2"	90	1095'	.025	White
	Part No.	Length	Pcs/Bundle	Ft./Bundle	Thickness	Finish
	129ML122-PK	12'2"	10	122'	.025	Mill/Unpainted
	129GR122-PK	12'2"	10	122'	.025	Gray
	129BZ122-PK	12'2"	10	122'	.025	Bronze
	129WH122-PK	12'2"	10	122'	.025	White
	SER-118	Part No.	Length	Pcs/Carton	Ft./Carton	Thickness
1/2" Lip frame  Use corner C115ML-040 or AC115BK (adjustable)	118ML122-BX	12'2"	70	852'	.025	Mill/Unpainted
	118GR122-BX	12'2"	70	852'	.025	Gray
	118BZ122-BX	12'2"	70	852'	.025	Bronze
	118WH122-BX	12'2"	70	852'	.025	White
	Part No.	Length	Pcs/Bundle	Ft./Bundle	Thickness	Finish
	118ML122-PK	12'2"	10	122'	.025	Mill/Unpainted
	118GR122-PK	12'2"	10	122'	.025	Gray
	118BZ122-PK	12'2"	10	122'	.025	Bronze
	118WH122-PK	12'2"	10	122'	.025	White
	SER-117	Part No.	Length	Pcs/Carton	Ft./Carton	Thickness
5/16" Lip frame  All above use spline size: .165 (Aluminum mesh) .185 (Fiberglass mesh) Use corner C117ML-020	117ML122-BX	12'2"	120	1460'	.020	Mill/Unpainted
	117GR122-BX	12'2"	120	1460'	.020	Gray
	117BZ122-BX	12'2"	120	1460'	.020	Bronze
	117WH122-BX	12'2"	120	1460'	.020	White
	117AL122-BX	12'2"	120	1460'	.020	Almond
	117AD122-BX	12'2"	120	1460'	.020	Adobe
	Part No.	Length	Pcs/Bundle	Ft./Bundle	Thickness	Finish
	117ML122-PK	12'2"	10	122'	.020	Mill/Unpainted
	117GR122-PK	12'2"	10	122'	.020	Gray
	117BZ122-PK	12'2"	10	122'	.020	Bronze
	117WH122-PK	12'2"	10	122'	.020	White
	117AL122-PK	12'2"	10	122'	.020	Almond
	117AD122-PK	12'2"	10	122'	.020	Adobe
	Corners	Description	Part No.	Pcs/Bag	Pcs/Carton	Thickness
	5/16" Lip frame corner	C117ML-020	100	1000	.020	Mill/Unpainted
	3/4" x 7/16" Miter cut corner	C115ML-040	100	1000	.040	Mill/Unpainted
	3/4" x 7/16" Miter cut corner	C115ML-050	100	1000	.050	Mill/Unpainted

ALUMINUM SCREEN FRAME SPREADER BAR

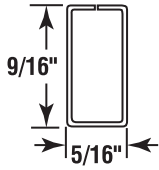
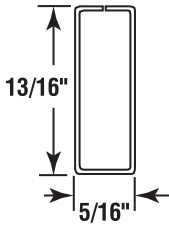
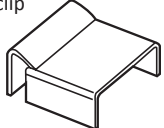
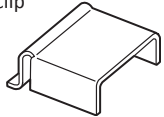
SER-128		Part No.	Length	Pcs/Carton	Ft./Carton	Thickness	Finish
5/8" Spreader bar 	128ML120-BX	12'0"	100	1200'	.025	Mill/Unpainted	
	128GR120-BX	12'0"	100	1200'	.025	Gray	
	128BZ120-BX	12'0"	100	1200'	.025	Bronze	
	128WH120-BX	12'0"	100	1200'	.025	White	
	128AL120-BX	12'0"	100	1200'	.025	Almond	
	128AD120-BX	12'0"	100	1200'	.025	Adobe	
	Part No.	Length	Pcs/Bundle	Ft./Bundle	Thickness	Finish	
	128ML120-BN	12'0"	50	600'	.025	Mill/Unpainted	
	128GR120-BN	12'0"	50	600'	.025	Gray	
	128BZ120-BN	12'0"	50	600'	.025	Bronze	
	128WH120-BN	12'0"	50	600'	.025	White	
	128AL120-BN	12'0"	50	600'	.025	Almond	
	128AD120-BN	12'0"	50	600'	.025	Adobe	
	128ML120-PK	12'0"	10	120'	.025	Mill/Unpainted	
	128GR120-PK	12'0"	10	120'	.025	Gray	
	128BZ120-PK	12'0"	10	120'	.025	Bronze	
	128WH120-PK	12'0"	10	120'	.025	White	
	128AL120-PK	12'0"	10	120'	.025	Almond	
	128AD120-PK	12'0"	10	120'	.025	Adobe	
	SER-127		Part No.	Length	Pcs/Carton	Ft./Carton	Thickness
7/8" Spreader bar 	127ML120-BX	12'0"	75	900'	.030	Mill/Unpainted	
	127GR120-BX	12'0"	75	900'	.030	Gray	
	127BZ120-BX	12'0"	75	900'	.030	Bronze	
	127WH120-BX	12'0"	75	900'	.030	White	
	127AL120-BX	12'0"	75	900'	.030	Almond	
	127AD120-BX	12'0"	75	900'	.030	Adobe	
	Part No.	Length	Pcs/Bundle	Ft./Bundle	Thickness	Finish	
	127ML120-PK	12'0"	10	120'	.030	Mill/Unpainted	
	127GR120-PK	12'0"	10	120'	.030	Gray	
	127BZ120-PK	12'0"	10	120'	.030	Bronze	
	127WH120-PK	12'0"	10	120'	.030	White	
	127AL120-PK	12'0"	10	120'	.030	Almond	
	127AD120-PK	12'0"	10	120'	.030	Adobe	
	Part No.	Pcs/Bag	Pcs/Carton	Finish			
159ML	100	1000	Mill/Unpainted				
7/8" Spreader bar clip							
							
Part No.	Pcs/Bag	Pcs/Carton	Finish				
160ML	100	1000	Mill/Unpainted				
5/8" Spreader bar clip							
							

ALUMINUM SCREEN FRAME ACCESSORIES

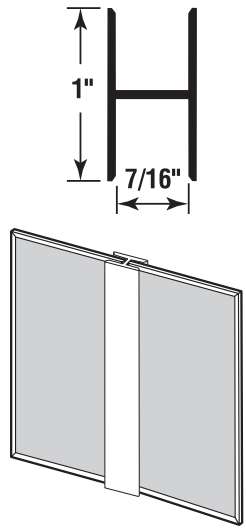
SER-130	Part No.	Length	Pcs/Carton	Ft./Carton	Thickness	Finish
7/16" Extruded "H" section 	130ML122-BX	12'2"	50	610'	.025	Mill/Unpainted
	130SA122-BX	12'2"	50	610'	.025	Satin anodized
	130BZ122-BX	12'2"	50	610'	.025	Bronze
	130WH122-BX	12'2"	50	610'	.025	White
	130AL122-BX	12'2"	50	610'	.025	Almond
	130AD122-BX	12'2"	50	610'	.025	Adobe
	Part No.	Length	Pcs/Bundle	Ft./Bundle	Thickness	Finish
	130ML122-PK	12'2"	10	122'	.025	Mill/Unpainted
	130SA122-PK	12'2"	10	122'	.025	Satin anodized
	130BZ122-PK	12'2"	10	122'	.025	Bronze
	130WH122-PK	12'2"	10	122'	.025	White
	130AL122-PK	12'2"	10	122'	.025	Almond
	130AD122-PK	12'2"	10	122'	.025	Adobe
	130ML122-EA	12'2"	1	12'2"	.025	Mill/Unpainted
130SA122-EA	12'2"	1	12'2"	.025	Satin anodized	
130BZ122-EA	12'2"	1	12'2"	.025	Bronze	
130WH122-EA	12'2"	1	12'2"	.025	White	
130AL122-EA	12'2"	1	12'2"	.025	Almond	
130AD122-EA	12'2"	1	12'2"	.025	Adobe	

SER-185	Part No.	Description	Diameters (all colors)	Finish
1" Screen frame circles  <p><i>Only sold in packs of 5</i></p>	185GR.xx	.025 Ga. 1" Screen frame circles Full circles only	24", 30", 36" 42", 48", 60" 72", 84", 96"	Gray
	185BZ.xx			Bronze
	185WH.xx			White
	185AL.xx			Almond
	185AD.xx			Adobe

NOTE:

50 piece bundles and 10 piece poly bagged packs available on most lineal items
 Less than pack quantities available on selected items only
 Screen corners now available in 100 piece poly bags



SCREEN FRAME ACCESSORIES

ADJUSTABLE CORNERS

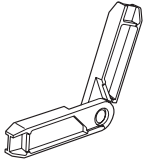
	Part No.	Size	Product Line	Pack QTY	Description	Finish
	AC115BK	3/4" x 7/16"	D1110	20/Bag	135° Plastic miter cut <i>Fits Precision 3/4" x 7/16" frame</i>	Black
	AC1130BK	1" x 7/16"	D1110	20/Bag	135° Plastic miter cut <i>Fits Precision 1" x 7/16" roll form frame</i>	Black

PLASTIC WICKETS

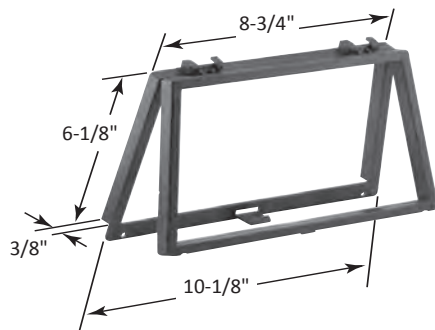

Part No.	Product Line	Color
190GR	A1150	Gray
190BZ	A1150	Bronze
190WH	A1150	White

- Allows access to awning or casement window operators.
- Available in three colors: gray, bronze, and white.
- Use either aluminum or fiberglass screen mesh to match the existing mesh in window screen.
- Requires a 12" minimum window screen width.

ALUMINUM WICKETS

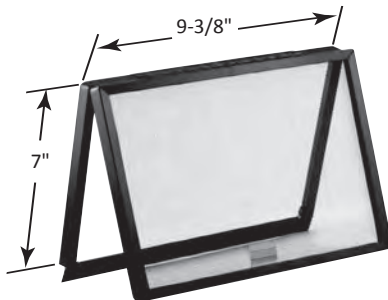

Part No.	Product Line	Color
188ML	A1150	Mill w/charcoal fiberglass
188BZ	A1150	Bronze w/charcoal fiberglass
188WH	A1150	White w/charcoal fiberglass
189ML	A1150	Mill w/charcoal fiberglass

SCREEN FRAME ACCESSORIES

DIECAST SCREEN CLIPS (Product Line: A1211)

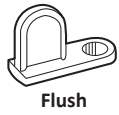

Size	Use screw #	Pack QTY	Adobe	Almond	Black	Bronze	Mill	White
Flush	#1052 Screw (10-24 x 5/8" S/T)	100/Bag	1660AD	1660AL	1660BK	1660BZ	1660ML	1660WH
1/16"	#1052 Screw (10-24 x 5/8" S/T)	100/Bag	1661AD	1661AL	1661BK	1661BZ	1661ML	1661WH
1/8"	#1052 Screw (10-24 x 5/8" S/T)	100/Bag	1662AD	1662AL	1662BK	1662BZ	1662ML	1662WH
3/16"	#1052 Screw (10-24 x 5/8" S/T)	100/Bag	1663AD	1663AL	1663BK	1663BZ	1663ML	1663WH
1/4"	#1052 Screw (10-24 x 5/8" S/T)	100/Bag	1664AD	1664AL	1664BK	1664BZ	1664ML	1664WH
5/16"	#1052 Screw (10-24 x 5/8" S/T)	100/Bag	1665AD	1665AL	1665BK	1665BZ	1665ML	1665WH
3/8"	#1052 Screw (10-24 x 5/8" S/T)	100/Bag	1666AD	1666AL	1666BK	1666BZ	1666ML	1666WH
7/16"	#1053 Screw (10-24 x 3/4" S/T)	100/Bag	1667AD	1667AL	1667BK	1667BZ	1667ML	1667WH
1-3/16"	#1055 Screw (10-24 x 1-5/8" S/T)	100/Bag	1668AD	1668AL	1668BK	1668BZ	1668ML	1668WH

All clips available in 1000 pieces per carton

PLASTIC SCREEN CLIPS (Product Line: D1310)

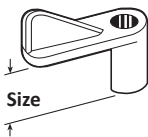
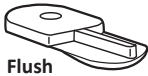

Size	Use screw #	Pack QTY	Black	Bronze	Gray	White
Flush	#1052 Screw (10-24 x 5/8" S/T)	100/Bag	—	—	—	194WH
1/16"	#1052 Screw (10-24 x 5/8" S/T)	100/Bag	—	170BZ	170GR	170WH
5/16"	#1052 Screw (10-24 x 5/8" S/T)	100/Bag	—	171BZ	171GR	—
3/8"	#1052 Screw (10-24 x 5/8" S/T)	100/Bag	—	172BZ	172GR	—
7/16"	#1053 Screw (10-24 x 3/4" S/T)	100/Bag	173BK	173BZ	173GR	173WH
1-3/16"	#1055 Screw (10-24 x 1-5/8" S/T)	100/Bag	—	197BZ	197GR	—

All clips available in 1000 pieces per carton

CASEMENT CLIPS (Product Line: D1310)

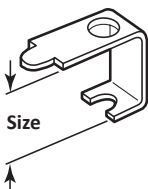

Size	Use screw #	Pack QTY	Part No.	Finish
5/16"	#1052 Screw (10-24 x 5/8" S/T)	1000/Ctn.	1780ML	Mill
3/8"	#1053 Screw (10-24 x 3/4" S/T)	1000/Ctn.	179ML	Mill
7/16"	#1053 Screw (10-24 x 3/4" S/T)	1000/Ctn.	180ML	Mill
7/8"	#1054 Screw (10-24 x 1-1/4" S/T)	1000/Ctn.	181ML	Mill
1-3/16"	#1055 Screw (10-24 x 1-5/8" S/T)	1000/Ctn.	182ML	Mill



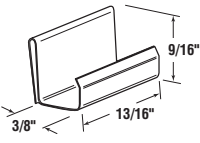
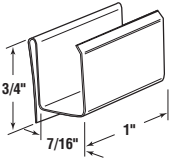
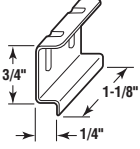
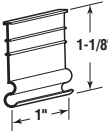
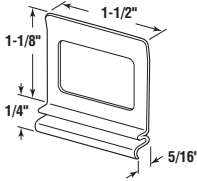

SCREEN FRAME ACCESSORIES

RETAINER CLIPS & PULL TABS (Product Line: D1310)

	Description	Material	Pack QTY	Mill	Black	White	Gray
	Retainer clips <i>For 3/8" frame</i>	Spring steel	1000/Ctn.	164ML	—	—	—
	Retainer clips <i>For 7/16" frame</i>	Spring steel	1000/Ctn.	165ML	—	—	—
	Spline channel pull tabs	Aluminum	1000/Ctn.	152ML	—	152WH	—
	Spline channel pull tabs	Plastic	1000/Ctn.	—	153BK	—	153GR
	Spline channel pull tabs	Plastic	1000/Ctn.	—	154BK	—	—

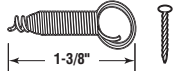
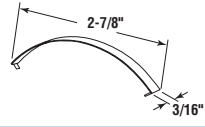
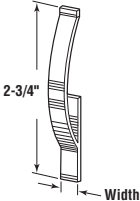
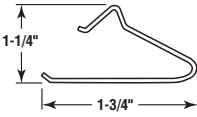
SPRINGS (Product Line: D1310)

	Description	Material	Pack QTY	Part No.
	Bottom latch springs	Stainless steel	1000/Ctn.	1550SS
	Flat springs	Spring steel	1000/Ctn.	1510ZP
	Flat springs <i>1/4" wide</i>	Spring steel	1000/Ctn.	1490ZP
	Flat springs <i>3/16" wide</i>	Spring steel	1000/Ctn.	1560ZP
	Wire springs	Spring steel	1000/Ctn.	1740CP
	Cone springs	Spring steel	1000/Ctn.	1630CP

See Prime-Line's
Professional Backroom
Window & Screen Repair
Catalog for complete
listing of replacement
hardware

SCREEN FRAME ACCESSORIES

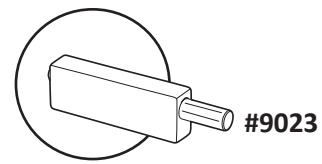

JIFFY HANGERS & BAIL LATCHES

	Material	Pack QTY	Finish	Part No.	Product Line
(2) Hangers & (1) latch For 7/16" frame 1 Set contains: 2 Hangers, 1 latch, (2) 13 x 3/4" spiral steel nails & 1 ball head screw	Aluminum	250 Sets / Box	Mill	146ML	A1210
	Aluminum	250 Sets / Box	Bronze	146BZ	A1210
	Aluminum	250 Sets / Box	White	146WH	A1210
	Aluminum	250 Sets / Box	Gray	146GR	A1210
Top hangers For 7/16" frame w/spiral steel nails	Aluminum	1000 / Box	Mill	144ML	A1210
	Aluminum	1000 / Box	Bronze	144BZ	A1210
	Aluminum	1000 / Box	White	144WH	A1210
	Aluminum	1000 / Box	Gray	144GR	A1210
Bottom latches For 7/16" frame	Aluminum	1000 / Box	Mill	145ML	A1210
	Aluminum	1000 / Box	Bronze	145BZ	A1210
	Aluminum	1000 / Box	White	145WH	A1210
	Aluminum	1000 / Box	Gray	145GR	A1210
Knife latches Use notching tool #9025	Aluminum	100 Pair	Mill	175ML	D1310

PLUNGER LATCHES & SLIDE LOCKS

	Material	Pack QTY	Part No.	Product Line
Plunger latches For 3/4" x 3/8" (or 7/16") frame Use step drill #9017 SNAP-ON STYLE	Black nylon	500 Sets	176BK	D1310
Plunger latches For 3/4" x 3/8" (or 7/16") frame Use step drill #9017 NAIL SET STYLE	All aluminum	100 Sets	176ML	D1310
Plunger latches For 1" x 7/16" Frame Use step drill #9017 NAIL SET STYLE	All aluminum	100 Sets	177ML	D1310
Slide lock For all 3/4" frames	Zinc plated steel	1000/Ctn.	161ML	D1310
Lock pins For all 3/4" frames	Steel	1000/Ctn.	1580CP	D1310



SCREEN FRAME ORDER GUIDE

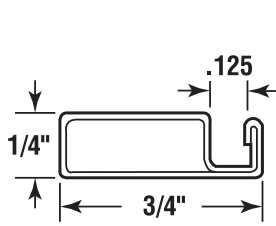

SER-123 (pg. 98)

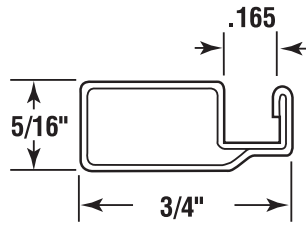

SER-520 (pg. 99)

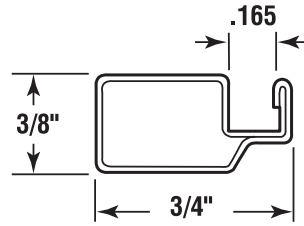

SER-519 (pg. 100)

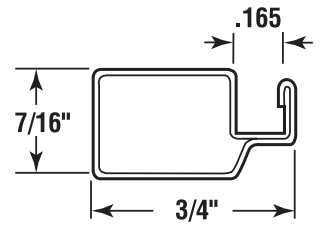

SER-516 (pg. 101)

* All dimensions are in inches

-- SPECIFICATIONS --

FRAME:	516 = 3/4" X 7/16" X .020	519 = 3/4" X 3/8" X .020			
	520 = 3/4" X 5/16" X .020	123 = 3/4" X 1/4" X .020			
FINISH:	ML = Mill	GR = Gray	WH = White	BZ = Bronze	AL = Almond
SCREEN:	Choice of Fiberglass; BetterVue Charcoal, 18 x 16 Charcoal or 18 x 16 Gray				
CORNERS:	Aluminum stamped inside corners.				
SPLINE:	Black serrated vinyl				
HARDWARE:	All above prices include: vinyl pull tabs and spring clips.				

-- OPTIONS --

SPREADER BAR:	\$.60 per lineal foot for addition of spreader bar.
SCREEN:	Aluminum 18 x 16; Silver = \$.32/Sq. Ft., Black or Charcoal = \$.38 Sq. Ft. Sun Control Charcoal or Gray; Sunscreen = \$1.10/Sq. Ft., Suntex = \$1.48/Sq. Ft. Ultra Vue = \$.52 Sq. Ft.; PetScreen Lite (Tuff Screen) = \$.880/Sq. Ft.

-- ORDERING GUIDE --

EXAMPLE: 3/4" X 3/8" FRAME WHITE 519WH SIZE 36" X 41"



CONDITIONS: Screens ordered cannot be cancelled or returned for credit. All purchases are final. 5 Day lead time. All screens are plastic wrapped together. Contact factory for special packaging charges.





MEASURING: Measure exact size required to the nearest 1/16". No deductions or additions will be made at the factory. For pricing use the next largest width or height shown on the price list.

SECTION 11 / TOOLS & SUPPLIES

PRODUCT	PAGE
Rolling tools & replacement wheels.....	118
Fasteners & rivets	118
Saw blades, shears, riveter, metal lube, saw wax, sealant, one way tool, adapter, step drill, notching jig & spray paint	119
Cut off gauge	120
Glass framing components & glazing vinyls	120

SCREEN ROLLING & SPECIALTY TOOLS

All wood handles

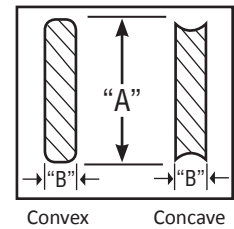

Product Line: K2500	Part No.	Wheel	Convex		Concave		Spline size
			A	B	A	B	
	PNSR-6000	Nylon	—	—	2"	3/32"	.115 - .145
	PNSR-6100	Nylon	—	—	2"	1/8"	.150 - .180
	PNSR-6200	Nylon	—	—	2"	5/32"	.185 - .215
	PNSR-6300	Nylon	—	—	2"	3/16"	.220 - .260
	PCR-7-20	Steel	2"	1/16"	2"	1/8"	.150 - .180
	PCR-6-22	Steel	2-1/2"	1/16"	2"	3/32"	.115 - .145
	PCR-7-22	Steel	2-1/2"	1/16"	2"	1/8"	.150 - .180
	PCR-8-22	Steel	2-1/2"	1/16"	2"	5/32"	.185 - .215
	PFR-4000 Flat roller	Steel	2" x 2" Flat				

Wheel measurements



MISCELLANEOUS TOOLS & SHOP SUPPLIES

SCREWS







	Part No.	Product Line	Pack QTY	Description
Screen clip screws Phillips pan head-self tapping 	1052	K2606	100/Ctn.	10-24 x 5/8" (Plated)
	1053	K2606	100/Ctn.	10-24 x 3/4" (Plated)
	1054	K2606	100/Ctn.	10-24 x 1-1/4" (Plated)
	1055	K2606	100/Ctn.	10-24 x 1-5/8" (Plated)
Ball head screws Slotted ball head 	1068	K2604	100/Ctn.	8 x 1-1/4" (Ball latch screws)

BLIND RIVETS

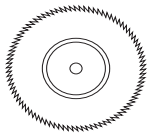
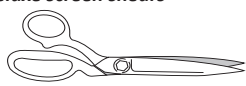
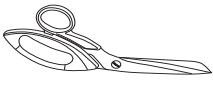
	Part No.	Product Line	Description	Body length	Grip range
Aluminum rivets w/carbon steel mandrels 1/8" Dia. 	1082	K2608	AD 41 BS	.170	.020 - .064
	1083	K2608	AD 42 BS	.232	.065 - .125
	1084	K2608	AD 43 BS	.294	.126 - .187
	1085 (Steel)	K2608	AD 44 BS	.357	.188 - .250
	1086	K2608	AD 45 BS	.415	.251 - .312
	1087	K2608	AD 46 BS	.481	.313 - .375

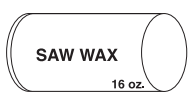
**Specify adobe, almond, black, bronze, or white*

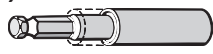
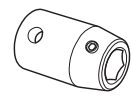
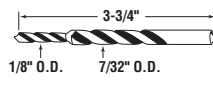
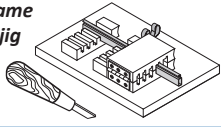
MISCELLANEOUS TOOLS & SHOP SUPPLIES

	Part No.	Product Line	Pack QTY	Description
Semi-high speed steel saw blades 	9593	K2500	1	(200 Teeth) 8" Diameter (Dia. x 1/16" x 5/8")
	9594	K2500	1	(200 Teeth) 10" Diameter (Dia. x 1/16" x 5/8")
	9596	K2500	1	(250 Teeth) 10" Diameter (Dia. x 1/16" x 5/8")
	<ul style="list-style-type: none"> • Carbon tool steel • For use on bench, radial arm and chop saws 		<ul style="list-style-type: none"> • 1/16" Thick 	<ul style="list-style-type: none"> • Type "A" teeth • 5/8" Arbor • Used for cutting screen and window frame
Deluxe screen shears 	9029	K2500	1	<ul style="list-style-type: none"> • 10" Heavy duty blades • Moly steel edge, resists abrasion • Offers easier cutting action • Use for fiberglass or aluminum screen
Heavy duty shears 	9030	K2500	1	<ul style="list-style-type: none"> • 11-1/4" Heavy duty blades • Stainless steel with adjustable screw • Ergonomic grip • Use for left or right handed cutting
Hand "pop" riveter 	9653	K2500	1	Sturdy, efficient hand riveter suitable for low production, prototype or field fastening applications. Comes equipped with interchangeable nosepiece for larger diameter rivets.
Precision metal lube 	1007	K2550	12/Case	13 oz. Aerosol can
Saw wax 	1014	K2550	1/Pkg. 12/Case	<ul style="list-style-type: none"> • (16 oz.) 1-1/2 # Tubes • Lubricant for chop saw blades • Allows for smoother saw cut and eliminates burring • Add life to saw blades
High performance sealant (clear) 	2858	F3807	1	100% Silicone (Acetoxy, permanent flexibility, excellent weatherability)
One way tool 	8900	G8100	1	5/16" One way driving tool
Adapter 	8901	G8100	1	5/16" Drive tool adapter, used for 1/2" square drive
Step drill 	9017	K2500	1	Step drill 7/32" x 1/8" — Used to easily drill correct hole sizes for installation of plunger latches
Screen frame notching jig 	9024	K2550	1/Box	<ul style="list-style-type: none"> • Allows frame to be securely held while being notched • Notched frame allows application of slide locks, tension springs and knife latches • Notching tool included
Precision spray paint (12 oz. Aerosol Can) 	8720 8721 8722 8723 8727 8757	G8705	12/Case	Semi gloss black Bronze Semi-gloss white Almond Adobe Weathered brown

MISCELLANEOUS TOOLS & SHOP SUPPLIES

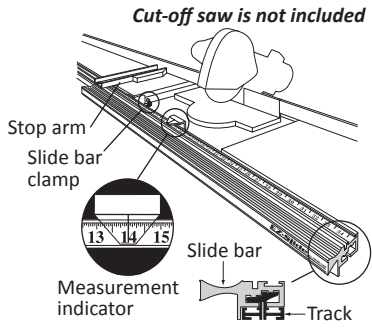

E-Z SLIDE CUT-OFF GAUGE

1. A unique measuring device for cut-off saws requiring fast and accurate lineal measuring.
2. Ideal for use with Precision's full size chop saw table kit (Part No. P 8061).
3. Accurately measures screen frame lengths from 6" to 108".
4. All measurements are read directly in front of chop saw, for maximum operator efficiency.

Recommended Gauge Selection

If operator is **LEFT HANDED**, order a **right** hand stop gauge.
If operator is **RIGHT HANDED**, order a **left** hand stop gauge.

Part No.	Product Line	Pack QTY	Description
9704	K2550	1	Right hand stop replacement tape for P 7925

GLASS FRAMING COMPONENTS & GLAZING VINYL

	Part No.	Product Line	Description	Finish	Length	Pcs/Pack
Glazing vinyl 	1104BK	K1510	SS Glazing vinyl	Black	750'	1
	1105BK	K1510	DS Glazing vinyl	Black	1000'	1
3/4" Muntin bar 	1111WH	A1010	3/4" Muntin bar .025	White	12'8"	125
Roll form glazing bead 	1127ML	A1010	Roll form glazing bead	Mill	12'0"	75
	1127GR	A1010	Roll form glazing bead	Gray	12'0"	75
	1127WH	A1010	Roll form glazing bead	White	12'0"	75
	1127BZ	A1010	Roll form glazing bead	Bronze	12'0"	75

*5 Box minimum

PRICE LIST

ATHENS (3550)

Product line D3002 / D3003

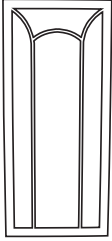

Size	List Price
3.00-6.08	\$395.00
3.00-7.01	\$410.00

Almond, Bronze, White

CAPRI (3230)

Product line D3000

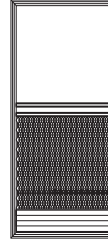

Size	List Price
2.08-6.08	\$127.00
3.00-6.08	

Bronze, Gray, White

BRIGHTON (3525)

Product line D3002 / D3011

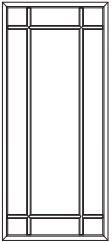

Size	List Price
2.06-6.08	\$212.00
2.08-6.08	
3.00-6.08	

Adobe, Almond, Black, Bronze, White

Up to:	Up to:	Up to:	Up to:	Up to:	Up to:
35-1/4" X 79-1/4"	35-1/4" X 95-1/4"	41-1/4" X 83-1/4"	41-1/4" X 95-1/4"	47-1/4" X 95-1/4"	47-1/4" X 119-1/4"
3068SDC	3080SDC	3670SDC	3680SDC	4080SDC	40100SDC
\$212.00	\$225.00	\$235.00	\$250.00	\$260.00	Call for price

Adobe, Almond, Black, Bronze, White

CENTURION (3610)

Product line D3003

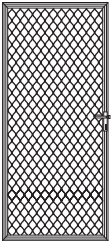

Size	List Price
2.06-6.08	\$480.00
2.08-6.08	
3.00-6.08	

Adobe, Almond, Black, Bronze, Bronze Anodized, Satin Anodized, White

Up to:	Up to:	Up to:	Up to:	Up to:
35-1/4" X 79-1/4"	35-1/4" X 95-1/4"	41-1/4" X 83-1/4"	41-1/4" X 95-1/4"	47-1/4" X 95-1/4"
3068SDC	3080SDC	3670SDC	3680SDC	4080SDC
\$480.00	\$490.00	\$495.00	\$500.00	N/A

Adobe, Almond, Black, Bronze, Bronze Anodized, Satin Anodized, White

CLEARVIEW (3510)

Product line D3002 / D3010

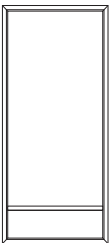

Size	List Price
2.06-6.08	\$178.00
2.08-6.08	
3.00-6.08	

Satin Anodized

Size	List Price
2.06-6.08	\$193.00
2.08-6.08	
3.00-6.08	

Adobe, Almond, Black, Bronze, White

Finish	Up to: 35-1/4" X 79-1/4"	Up to: 35-1/4" X 95-1/4"	Up to: 41-1/4" X 83-1/4"	Up to: 41-1/4" X 95-1/4"	Up to: 47-1/4" X 95-1/4"	Up to: 47-1/4" X 119-1/4"
Bronze Anodized, Satin Anodized	3068SDC \$178.00	3080SDC \$208.00	3670SDC \$212.00	3680SDC \$235.00	4080SDC \$250.00	40100SDC \$270.00
Adobe, Almond, Black, Bronze, White	\$193.00	\$225.00	\$230.00	\$235.00	\$250.00	\$270.00

PRICE LIST

EFFECTIVE: 9-1-2016

COLONADE (3520)

Product line D3002 / D3011

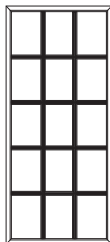

Size	List Price
2.06-6.08	\$210.00
2.08-6.08	
3.00-6.08	

Adobe, Almond, Bronze, White

Up to: 35-1/4" X 79-1/4"	Up to: 35-1/4" X 95-1/4"	Up to: 41-1/4" X 83-1/4"	Up to: 41-1/4" X 95-1/4"	Up to: 47-1/4" X 95-1/4"	Up to: 47-1/4" X 119-1/4"
3068SDC	3080SDC	3670SDC	3680SDC	4080SDC	40100SDC
\$210.00	\$228.00	\$235.00	\$235.00	\$250.00	\$270.00

Adobe, Almond, Black, Bronze, White

FIESTA (3530)

Product line D3002 / D3010

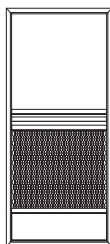

Size	List Price
2.06-6.08	\$204.00
2.08-6.08	
3.00-6.08	

Mill

Size	List Price
2.06-6.08	\$206.00
2.08-6.08	
3.00-6.08	

Satin Anodized

Size	List Price
2.06-6.08	\$224.00
2.08-6.08	
3.00-6.08	

Adobe, Almond, Black,
Bronze, White

Size	List Price
2.06-6.08	\$235.00
2.08-6.08	
3.00-6.08	

Bronze Anodized

Finish	Up to: 35-1/4" X 79-1/4"	Up to: 35-1/4" X 95-1/4"	Up to: 41-1/4" X 83-1/4"	Up to: 41-1/4" X 95-1/4"	Up to: 47-1/4" X 95-1/4"	Up to: 47-1/4" X 119-1/4"
	3068SDC	3080SDC	3670SDC	3680SDC	4080SDC	40100SDC
Mill	\$204.00	\$204.00	\$218.00	Call for price	\$260.00	Call for price
Satin Anodized	\$206.00	\$220.00	\$230.00	\$248.00	\$267.00	Call for price
Adobe, Almond, Black, Bronze, White	\$224.00	\$240.00	\$250.00	\$270.00	\$290.00	\$310.00
Bronze Anodized	\$235.00	\$240.00	\$245.00	Call for price	Call for price	Call for price

OCEANSIDE (3540)

Product line D3002

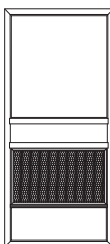

Size	List Price
2.06-6.08	\$365.00
2.08-6.08	
3.00-6.08	

Adobe, Almond, Black, Bronze, Satin Anodized,
White

Up to: 35-1/4" X 79-1/4"	Up to: 35-1/4" X 95-1/4"	Up to: 41-1/4" X 83-1/4"	Up to: 41-1/4" X 95-1/4"	Up to: 47-1/4" X 95-1/4"	Up to: 47-1/4" X 119-1/4"
3068SDC	3080SDC	3670SDC	3680SDC	4080SDC	40100SDC
\$365.00	Call for price	Call for price	Call for price	Call for price	Call for price

Adobe, Almond, Black, Bronze, Satin Anodized, White

PRICE LIST

PROMO (3210)

Product line D3000

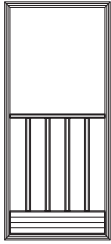

Size	List Price
2.08-6.08	\$98.00
3.00-6.08	

Gray

PROVENCIAL (3480)

Product line D3001



Size	List Price
2.08-6.08	\$145.00
3.00-6.08	

Bronze, Gray, White

SAFEGUARD (3517)

Product line D3002 / D3010

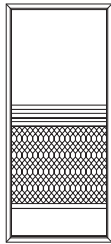

Size	List Price
2.06-6.08	\$235.00
2.08-6.08	
3.00-6.08	

Satin Anodized

Size	List Price
2.06-6.08	\$255.00
2.08-6.08	
3.00-6.08	

Adobe, Almond, Black, Bronze, White
Bronze Anodized

Finish	Up to: 35-1/4" X 79-1/4"	Up to: 35-1/4" X 95-1/4"	Up to: 41-1/4" X 83-1/4"	Up to: 41-1/4" X 95-1/4"	Up to: 47-1/4" X 95-1/4"	Up to: 47-1/4" X 119-1/4"
	3068SDC	3080SDC	3670SDC	3680SDC	4080SDC	40100SDC
Satin Anodized	\$235.00	\$255.00	\$272.00	\$277.00	\$281.00	\$286.00
Adobe, Almond, Black, Bronze, White, Bronze Anodized,	\$255.00	\$277.00	\$295.00	\$300.00	\$305.00	\$310.00

SANTA CRUZ FULL GRILLE (3522)

Product line D3002

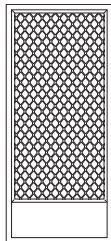

Size	List Price
2.06-6.08	\$374.00
2.08-6.08	
3.00-6.08	

Adobe, Almond, Black, Bronze, Satin Anodized, White

Up to: 35-1/4" X 79-1/4"	Up to: 35-1/4" X 95-1/4"	Up to: 41-1/4" X 81"	Up to: 41-1/4" X 95-1/4"	Up to: 47-1/4" X 95-1/4"	Up to: 47-1/4" X 119-1/4"
3068SDC	3080SDC	3670SDC	3680SDC	4080SDC	40100SDC
\$374.00	\$410.00	\$410.00	\$410.00	N/A	N/A

Adobe, Almond, Black, Bronze, White

SANTA CRUZ (3521)

Product line D3002

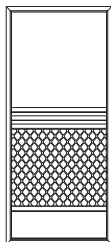

Size	List Price
2.06-6.08	\$255.00
2.08-6.08	
3.00-6.08	

Adobe, Almond, Black, Bronze, Satin Anodized, White

Up to: 35-1/4" X 79-1/4"	Up to: 35-1/4" X 95-1/4"	Up to: 41-1/4" X 83-1/4"	Up to: 41-1/4" X 95-1/4"	Up to: 47-1/4" X 95-1/4"	Up to: 41-1/4" X 119-1/4"
3068SDC	3080SDC	3670SDC	3680SDC	4080SDC	40100SDC
\$255.00	\$310.00	\$288.00	\$310.00	N/A	Call for price

Adobe, Almond, Black, Bronze, Satin Anodized, White

PRICE LIST

EFFECTIVE: 9-1-2016

VANGUARD (3660)

Product line D3003

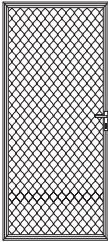

Size	List Price
2.06-6.08	\$455.00
2.08-6.08	
3.00-6.08	

Bronze, White

CUSTOM OPTIONS

Product line D9999

Option	Option Code	Description	List Price
Frame	OP-1PB-1	Install 1 each #288PB - 1-1/8" Extruded Push Bar	\$11.85
	OP-1PB-2	Install 2 each #288PB - 1-1/8" Extruded Push Bar	\$23.70
	OP-1PB-3	Install 3 each #288PB - 1-1/8" Extruded Push Bar	\$35.55
	OP-ADDKPLATE-9	Install a 9" kickplate in place of stock kickplate	\$17.78
	OP-ADDKPLATE-12	Install a 12" kickplate in place of stock kickplate	\$24.89
	OP-ADDKPLATE-20	Install a 20" kickplate in place of stock kickplate	\$32.00
	OP-NOKICKPLATE	Remove Kickplate; Delete Kickplate	N/C
	OP-SWSLOT4HNDL	Special placement security door lock (Centurion only)	\$31.40
Handle	2960xx	Add new designer hardware (extruded doors only) Available colors (replace xx): AB, BK, BR, BZ, SN & WH	\$55.00
	2965	Cylinders keyed alike (Centurion only)	\$23.60
Hinge	OP-ADDDHINGE-1	Additional hinge to channel (special hinge placement on channel)	\$8.00
Pre-hung frame for aluminum doors	OP-PREHUNG	Available pre-installed on door only (available in satin, white or bronze)	\$59.25
Pet door	OP-PD-SWG-S	Install pet door centered – small	\$165.90
	OP-PD-SWG-M	Install pet door centered – medium	\$228.71
	OP-PD-SWG-L	Install pet door centered – large	\$290.33
	OP-PD-SWG-X	Install pet door centered – extra large	\$374.46
Screen cloth	OP-SC14CF	Charcoal fiber 18" x 14"	\$0.24 / sq ft.
	OP-SC16BA	Brite silver aluminum 18" x 16"	\$0.38 / sq ft.
	OP-SCPSBK	Black pet screen	\$1.64 / sq ft.
	OP-SCSSCF	Charcoal sunscreen	\$1.30 / sq ft.
	OP-SCSTBK	Black sun tex	\$1.75 / sq ft.
	OP-SC16BV	Better view	\$.302 / sq ft.

GEORGIAN DESIGNER HARDWARE (OP-HNDL2129)

Product line F3320

Finish	Part No.	List Price
Black	2129BK	\$46.50
Brass	2129BR	\$46.50
Satin nickel	2129SN	\$46.50
White	2129WH	\$46.50

STANDARD HARDWARE KIT PACK

Product line F3320

Finish	Part No.	List Price
Adobe	2090AD	\$18.00
Almond	2090AL	\$18.00
Black	2090BK	\$18.00
Bronze	2090BZ	\$18.00
Silver	2090SL	\$18.00
White	2090WH	\$18.00

PRICE LIST

EFFECTIVE: 9-1-2016

ONE-PIECE SCREEN DOOR ASTRAGAL

Product line F3950

Finish	Size - (84")	List Price	Size - (96")	List Price
Adobe	2920AD	\$43.89	2921AD	\$48.40
Almond	2920AL	\$43.89	2921AL	\$48.40
Black	2920BK	\$43.89	2921BK	\$48.40
Bronze	2920BZ	\$43.89	2921BZ	\$48.40
Bronze anodized	2920BA	\$49.50	2921BA	\$48.40
Satin anodized	2920SA	\$43.89	2921SA	\$48.40
White	2920WH	\$43.89	2921WH	\$48.40

DOUBLE SCREEN DOOR KITS

Product line F3950

Finish	Size - (84")	List Price	Size - (96")	List Price
Adobe	2911AD-84	\$40.15	2912AD-96	\$43.78
Almond	2911AL-84	\$40.15	2912AL-96	\$43.78
Black	2911BK-84	\$40.15	2912BK-96	\$43.78
Bronze	2911BZ-84	\$40.15	2912BZ-96	\$43.78
Bronze anodized	2911BA-84	\$40.15	2912BA-96	\$43.78
Satin anodized	2911SA-84	\$40.15	2912SA-96	\$43.78
White	2911WH-84	\$40.15	2912WH-96	\$43.78

DOUBLE SECURITY SCREEN DOOR KITS

Product line F3950

Finish	Size - (84")	List Price	Size - (96")	List Price
Bronze	2976BZ-84	\$56.00	2981BZ-96	\$64.00
White	2976WH-84	\$56.00	2981WH-96	\$64.00

Fits Centurion, Athens and Vanguard

BOTTOM & HINGE ADJUSTMENT CHANNELS (FOR STEEL DOORS)

Product line F3320

Finish	Bottom channel 36" (BAC)	List Price	Hinge channel 81" (HSAC)	List Price
Bronze	2037BZ	\$7.79	2044BZ	\$23.01
Gray	2037GR	\$7.79	2044GR	\$23.01
White	2037WH	\$7.79	2044WH	\$23.01

BOTTOM & HINGE ADJUSTMENT CHANNELS

Finish	Product Line	Bottom channel 36" (BAC)	List Price
--------	--------------	-----------------------------	------------

Extruded Aluminum Doors

Adobe	F3320	2036AD	\$9.74
Almond	F3320	2036AL	\$9.74
Black	F3320	2036BK	\$9.74
Bronze	F3320	2036BZ	\$9.74
Bronze Anodized	F3320	2036BA	\$10.62
Mill	F3320	2036ML	\$8.26
Satin Anodized	F3320	2036SA	\$9.74
White	F3320	2036WH	\$9.74

Hinge channel 81" (HSAC)	List Price
-----------------------------	------------

2041AD	\$33.08
2041AL	\$33.08
2041BK	\$33.08
2041BZ	\$33.08
2041BA	\$33.08
2041ML	\$33.08
2041SA	\$33.08
2041WH	\$33.08

Hinge channel 96" (HSAC)	List Price
-----------------------------	------------

2076AD	\$35.99
2076AL	\$35.99
2076BK	\$35.99
2076BZ	\$35.99
2076BA	\$35.99
2076ML	Call for price
2076SA	Call for price
2076WH	\$35.99

Extruded Aluminum Security Doors

Black	F3970	2946BK	\$14.99
Bronze	F3970	2946BZ	\$14.99
White	F3970	2946WH	\$14.99

2953BK	\$77.50
2953BZ	\$77.50
2953WH	\$77.50

Black Vinyl Sweep	F3320	2975BK-750	\$0.32 per Lineal Foot
--------------------------	-------	------------	------------------------

Screen Door Hinge

Adobe	F3850	2175AD	Call for price
Almond	F3850	2175AL	Call for price
Bronze	F3850	2175BZ	Call for price
White	F3850	2175WH	Call for price

PRICE LIST

BARCELONA (3804)

Product line G3007 / G3012

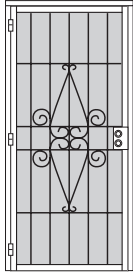

Single Door Standard Size

Size	List Price
2.06-6.08	\$470.00
2.08-6.08	\$470.00
3.00-6.08	\$470.00

Single Door Custom Size

Up to:	Up to:	Up to:	Up to:
39-1/2" X 83-1/2" Net	39-1/2" X 99-1/2" Net	51-1/2" X 99-1/2" Net	51-1/2" X 123-1/2" Net
\$470.00	\$532.00	\$610.00	\$650.00

Double Door Standard Size

Size	List Price
5.00-6.08	\$1,025.00
5.04-6.08	\$1,025.00
6.00-6.08	\$1,125.00

Double Door Custom Size

Up to:	Up to:	Up to:	Up to:
75-1/2" X 83-1/2" Net	75-1/2" X 99-1/2" Net	99-1/2" X 99-1/2" Net	99-1/2" X 123-1/2" Net
\$1,125.00	\$1,249.00	\$1,405.00	\$1,485.00

Adobe, Almond, Black, Bronze, Weathered Brown, White

CAROLINA (3811)

Product line G3012

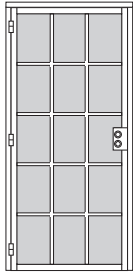

Single Door Standard Size

Size	List Price
2.06-6.08	\$580.00
2.08-6.08	\$580.00
3.00-6.08	\$580.00

Single Door Custom Size

Up to:	Up to:	Up to:	Up to:
39-1/2" X 83-1/2" Net	39-1/2" X 99-1/2" Net	51-1/2" X 99-1/2" Net	51-1/2" X 123-1/2" Net
\$580.00	\$640.00	\$710.00	\$780.00

Double Door Standard Size

Size	List Price
5.00-6.08	\$1,010.00
5.04-6.08	\$1,010.00
6.00-6.08	\$1,010.00

Double Door Custom Size

Up to:	Up to:	Up to:	Up to:
75-1/2" X 83-1/2" Net	75-1/2" X 99-1/2" Net	99-1/2" X 99-1/2" Net	99-1/2" X 123-1/2" Net
\$1,010.00	\$1,180.00	\$1,420.00	\$1,745.00

Adobe, Almond, Black, Bronze, Weathered Brown, White

CLARION (3821)

Product line G3007 / G3012

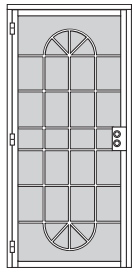

Single Door Standard Size

Size	List Price
2.06-6.08	\$750.00
2.08-6.08	\$750.00
3.00-6.08	\$750.00

Single Door Custom Size

Up to:	Up to:	Up to:	Up to:
39-1/2" X 83-1/2" Net	39-1/2" X 99-1/2" Net	51-1/2" X 99-1/2" Net	51-1/2" X 123-1/2" Net
\$750.00	\$840.00	\$880.00	\$990.00

Double Door Standard Size

Size	List Price
5.00-6.08	\$1,290.00
5.04-6.08	\$1,290.00
6.00-6.08	\$1,330.00

Double Door Custom Size

Up to:	Up to:	Up to:	Up to:
75-1/2" X 83-1/2" Net	75-1/2" X 99-1/2" Net	99-1/2" X 99-1/2" Net	99-1/2" X 123-1/2" Net
\$1,330.00	1,330.00	\$1,440.00	\$1,520.00

Adobe, Almond, Black, Bronze, Weathered Brown, White

DAKOTA (3814)

Product line G3007 / G3012

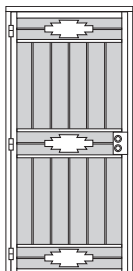

Single Door Standard Size

Size	List Price
2.06-6.08	\$690.00
2.08-6.08	\$690.00
3.00-6.08	\$690.00

Single Door Custom Size

Up to:	Up to:	Up to:	Up to:
39-1/2" X 83-1/2" Net	39-1/2" X 99-1/2" Net	51-1/2" X 99-1/2" Net	51-1/2" X 123-1/2" Net
\$690.00	\$730.00	\$790.00	\$820.00

Double Door Standard Size

Size	List Price
5.00-6.08	\$1,410.00
5.04-6.08	\$1,410.00
6.00-6.08	\$1,565.00

Double Door Custom Size

Up to:	Up to:	Up to:	Up to:
75-1/2" X 83-1/2" Net	75-1/2" X 99-1/2" Net	99-1/2" X 99-1/2" Net	99-1/2" X 123-1/2" Net
\$1,565.00	\$1,645.00	\$1,765.00	\$1,825.00

Adobe, Almond, Black, Bronze, Weathered Brown, White

PRICE LIST

EFFECTIVE: 9-1-2016

DECO (3842)

Product line G3012

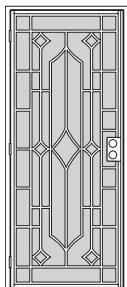

Single Door Standard Size

Size	List Price
2.06-6.08	\$1,080.00
2.08-6.08	\$1,080.00
3.00-6.08	\$1,080.00

Single Door Custom Size

Up to: 39-1/2" X 83-1/2" Net	Up to: 39-1/2" X 99-1/2" Net	Up to: 51-1/2" X 99-1/2" Net	Up to: 51-1/2" X 123-1/2" Net
\$1,080.00	\$1,290.00	\$1,590.00	\$1,720.00

Double Door Standard Size

Size	List Price
5.00-6.08	\$1,870.00
5.04-6.08	\$1,870.00
6.00-6.08	\$1,910.00

Double Door Custom Size

Up to: 75-1/2" X 83-1/2" Net	Up to: 75-1/2" X 99-1/2" Net	Up to: 99-1/2" X 99-1/2" Net	Up to: 99-1/2" X 123-1/2" Net
\$1,910.00	\$1,950.00	\$2,050.00	\$2,410.00

Adobe, Almond, Black, Bronze, Weathered Brown, White

ENGLISH IVY (3829)

Product line G3012



Single Door Standard Size

Size	List Price
2.06-6.08	\$770.00
2.08-6.08	\$770.00
3.00-6.08	\$770.00

Single Door Custom Size

Up to: 39-1/2" X 83-1/2" Net	Up to: 39-1/2" X 99-1/2" Net	Up to: 51-1/2" X 99-1/2" Net	Up to: 51-1/2" X 123-1/2" Net
\$770.00	\$830.00	\$950.00	\$1,100.00

Double Door Standard Size

Size	List Price
5.00-6.08	\$1,725.00
5.04-6.08	\$1,725.00
6.00-6.08	\$1,725.00

Double Door Custom Size

Up to: 75-1/2" X 83-1/2" Net	Up to: 75-1/2" X 99-1/2" Net	Up to: 99-1/2" X 99-1/2" Net	Up to: 99-1/2" X 123-1/2" Net
\$1,725.00	\$1,845.00	\$2,085.00	\$2,385.00

Adobe, Almond, Black, Bronze, Weathered Brown, White

FRANCISCAN (3815)

Product line G3012

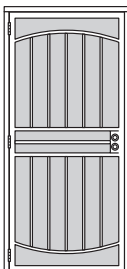

Single Door Standard Size

Size	List Price
2.06-6.08	\$620.00
2.08-6.08	\$620.00
3.00-6.08	\$620.00

Single Door Custom Size

Up to: 39-1/2" X 83-1/2" Net	Up to: 39-1/2" X 99-1/2" Net	Up to: 51-1/2" X 99-1/2" Net	Up to: 51-1/2" X 123-1/2" Net
\$620.00	\$690.00	\$760.00	\$790.00

Double Door Standard Size

Size	List Price
5.00-6.08	\$1,325.00
5.04-6.08	\$1,325.00
6.00-6.08	\$1,425.00

Double Door Custom Size

Up to: 75-1/2" X 83-1/2" Net	Up to: 75-1/2" X 99-1/2" Net	Up to: 99-1/2" X 99-1/2" Net	Up to: 99-1/2" X 123-1/2" Net
\$1,425.00	\$1,565.00	\$1,705.00	\$1,765.00

Adobe, Almond, Black, Bronze, Weathered Brown, White

GRANADA (3803)

Product line G3007 / G3012

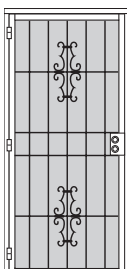

Single Door Standard Size

Size	List Price
2.06-6.08	\$490.00
2.08-6.08	\$490.00
3.00-6.08	\$490.00

Single Door Custom Size

Up to: 39-1/2" X 83-1/2" Net	Up to: 39-1/2" X 99-1/2" Net	Up to: 51-1/2" X 99-1/2" Net	Up to: 51-1/2" X 123-1/2" Net
\$490.00	\$550.00	\$640.00	\$670.00

Double Door Standard Size

Size	List Price
5.00-6.08	\$1,065.00
5.04-6.08	\$1,065.00
6.00-6.08	\$1,165.00

Double Door Custom Size

Up to: 75-1/2" X 83-1/2" Net	Up to: 75-1/2" X 99-1/2" Net	Up to: 99-1/2" X 99-1/2" Net	Up to: 99-1/2" X 123-1/2" Net
\$1,165.00	\$1,285.00	\$1,465.00	\$1,525.00

Adobe, Almond, Black, Bronze, Weathered Brown, White

PRICE LIST

IMPERIAL (3831)

Product line G3009 / G3012

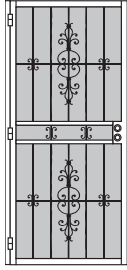

Single Door Standard Size

Size	List Price
2.06-6.08	\$550.00
2.08-6.08	\$550.00
3.00-6.08	\$550.00

Single Door Custom Size

Up to: 39-1/2" X 83-1/2" Net	Up to: 39-1/2" X 99-1/2" Net	Up to: 51-1/2" X 99-1/2" Net	Up to: 51-1/2" X 123-1/2" Net
\$550.00	\$590.00	\$650.00	\$690.00

Double Door Standard Size

Size	List Price
5.00-6.08	\$1,030.00
5.04-6.08	\$1,030.00
6.00-6.08	\$1,130.00

Double Door Custom Size

Up to: 75-1/2" X 83-1/2" Net	Up to: 75-1/2" X 99-1/2" Net	Up to: 99-1/2" X 99-1/2" Net	Up to: 99-1/2" X 123-1/2" Net
\$1,130.00	\$1,280.00	\$1,420.00	\$1,510.00

Adobe, Almond, Black, Bronze, Weathered Brown, White

IMPRESSIONS (3822)

Product line G3012



Single Door Standard Size

Size	List Price
2.06-6.08	\$790.00
2.08-6.08	\$790.00
3.00-6.08	\$790.00

Single Door Custom Size

Up to: 39-1/2" X 83-1/2" Net	Up to: 39-1/2" X 99-1/2" Net	Up to: 51-1/2" X 99-1/2" Net	Up to: 51-1/2" X 123-1/2" Net
\$790.00	\$840.00	\$980.00	\$1,090.00

Double Door Standard Size

Size	List Price
5.00-6.08	\$1,410.00
5.04-6.08	\$1,410.00
6.00-6.08	\$1,510.00

Double Door Custom Size

Up to: 75-1/2" X 83-1/2" Net	Up to: 75-1/2" X 99-1/2" Net	Up to: 99-1/2" X 99-1/2" Net	Up to: 99-1/2" X 123-1/2" Net
\$1,510.00	\$1,780.00	\$1,960.00	\$2,180.00

Adobe, Almond, Black, Bronze, Weathered Brown, White

ITALIAN LEAF (3824)

Product line G3012



Single Door Standard Size

Size	List Price
2.06-6.08	\$730.00
2.08-6.08	\$730.00
3.00-6.08	\$730.00

Single Door Custom Size

Up to: 39-1/2" X 83-1/2" Net	Up to: 39-1/2" X 99-1/2" Net	Up to: 51-1/2" X 99-1/2" Net	Up to: 51-1/2" X 123-1/2" Net
\$730.00	\$780.00	\$920.00	\$1,060.00

Double Door Standard Size

Size	List Price
5.00-6.08	\$1,560.00
5.04-6.08	\$1,560.00
6.00-6.08	\$1,560.00

Double Door Custom Size

Up to: 75-1/2" X 83-1/2" Net	Up to: 75-1/2" X 99-1/2" Net	Up to: 99-1/2" X 99-1/2" Net	Up to: 99-1/2" X 123-1/2" Net
\$1,560.00	\$1,680.00	\$1,940.00	\$2,220.00

Adobe, Almond, Black, Bronze, Weathered Brown, White

MADRID (3806)

Product line G3012

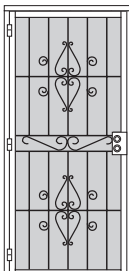

Single Door Standard Size

Size	List Price
2.06-6.08	\$460.00
2.08-6.08	\$460.00
3.00-6.08	\$460.00

Single Door Custom Size

Up to: 39-1/2" X 83-1/2" Net	Up to: 39-1/2" X 99-1/2" Net	Up to: 51-1/2" X 99-1/2" Net	Up to: 51-1/2" X 123-1/2" Net
\$460.00	\$530.00	\$590.00	\$720.00

Double Door Standard Size

Size	List Price
5.00-6.08	\$1,070.00
5.04-6.08	\$1,070.00
6.00-6.08	\$1,070.00

Double Door Custom Size

Up to: 75-1/2" X 83-1/2" Net	Up to: 75-1/2" X 99-1/2" Net	Up to: 99-1/2" X 99-1/2" Net	Up to: 99-1/2" X 123-1/2" Net
\$1,070.00	\$1,210.00	\$1,320.00	\$1,490.00

Adobe, Almond, Black, Bronze, Weathered Brown, White

PRICE LIST

EFFECTIVE: 9-1-2016

PARADISE (3808)

Product line G3007 / G3012



Single Door Standard Size

Size	List Price
2.06-6.08	\$670.00
2.08-6.08	\$670.00
3.00-6.08	\$670.00

Single Door Custom Size

Up to: 39-1/2" X 83-1/2" Net	Up to: 39-1/2" X 99-1/2" Net	Up to: 51-1/2" X 99-1/2" Net	Up to: 51-1/2" X 123-1/2" Net
\$670.00	\$710.00	\$770.00	\$870.00

Double Door Standard Size

Size	List Price
5.00-6.08	\$1,230.00
5.04-6.08	\$1,230.00
6.00-6.08	\$1,380.00

Double Door Custom Size

Up to: 75-1/2" X 83-1/2" Net	Up to: 75-1/2" X 99-1/2" Net	Up to: 99-1/2" X 99-1/2" Net	Up to: 99-1/2" X 123-1/2" Net
\$1,380.00	\$1,520.00	\$1,640.00	\$1,840.00

Adobe, Almond, Black, Bronze, Weathered Brown, White

SAN MARINO (3840)

Product line G3012

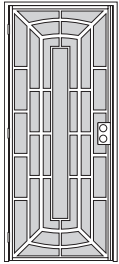

Single Door Standard Size

Size	List Price
2.06-6.08	\$1,080.00
2.08-6.08	\$1,080.00
3.00-6.08	\$1,080.00

Single Door Custom Size

Up to: 39-1/2" X 83-1/2" Net	Up to: 39-1/2" X 99-1/2" Net	Up to: 51-1/2" X 99-1/2" Net	Up to: 51-1/2" X 123-1/2" Net
\$1,080.00	\$1,290.00	\$1,590.00	\$1,720.00

Double Door Standard Size

Size	List Price
5.00-6.08	\$1,870.00
5.04-6.08	\$1,870.00
6.00-6.08	\$1,910.00

Double Door Custom Size

Up to: 75-1/2" X 83-1/2" Net	Up to: 75-1/2" X 99-1/2" Net	Up to: 99-1/2" X 99-1/2" Net	Up to: 99-1/2" X 123-1/2" Net
\$1,910.00	\$1,950.00	\$2,050.00	\$2,190.00

Adobe, Almond, Black, Bronze, Weathered Brown, White

SONOMA (3830)

Product line G3012



Single Door Standard Size

Size	List Price
2.06-6.08	\$760.00
2.08-6.08	\$760.00
3.00-6.08	\$760.00

Single Door Custom Size

Up to: 39-1/2" X 83-1/2" Net	Up to: 39-1/2" X 99-1/2" Net	Up to: 51-1/2" X 99-1/2" Net	Up to: 51-1/2" X 123-1/2" Net
\$760.00	\$820.00	\$940.00	\$1,050.00

Double Door Standard Size

Size	List Price
5.00-6.08	\$1,590.00
5.04-6.08	\$1,590.00
6.00-6.08	\$1,590.00

Double Door Custom Size

Up to: 75-1/2" X 83-1/2" Net	Up to: 75-1/2" X 99-1/2" Net	Up to: 99-1/2" X 99-1/2" Net	Up to: 99-1/2" X 123-1/2" Net
\$1,590.00	\$1,720.00	\$1,930.00	\$2,110.00

Adobe, Almond, Black, Bronze, Weathered Brown, White

STEEL MASTER (3812)

Product line G3007 / G3012

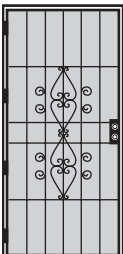

Single Door Standard Size

Size	List Price
2.06-6.08	\$750.00
2.08-6.08	\$750.00
3.00-6.08	\$750.00

Single Door Custom Size

Up to: 39-1/2" X 83-1/2" Net	Up to: 39-1/2" X 99-1/2" Net	Up to: 51-1/2" X 99-1/2" Net	Up to: 51-1/2" X 123-1/2" Net
\$750.00	\$770.00	\$820.00	\$870.00

Double Door Standard Size

Size	List Price
5.00-6.08	\$1,480.00
5.04-6.08	\$1,480.00
6.00-6.08	\$1,480.00

Double Door Custom Size

Up to: 75-1/2" X 83-1/2" Net	Up to: 75-1/2" X 99-1/2" Net	Up to: 99-1/2" X 99-1/2" Net	Up to: 99-1/2" X 123-1/2" Net
\$1,480.00	\$1,510.00	\$1,540.00	\$1,600.00

Adobe, Almond, Black, Bronze, Weathered Brown, White

PRICE LIST

SUNBURST (3841)

Product line G3007 / G3012

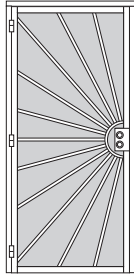

Single Door Standard Size

Size	List Price
2.06-6.08	\$660.00
2.08-6.08	\$660.00
3.00-6.08	\$660.00

Single Door Custom Size

Up to:	Up to:	Up to:	Up to:
39-1/2" X 83-1/2"	39-1/2" X 99-1/2"	51-1/2" X 99-1/2"	51-1/2" X 123-1/2"
Net	Net	Net	Net
\$660.00	\$710.00	\$760.00	\$810.00

Double Door Standard Size

Size	List Price
5.00-6.08	\$990.00
5.04-6.08	\$990.00
6.00-6.08	\$990.00

Double Door Custom Size

Up to:	Up to:	Up to:	Up to:
75-1/2" X 83-1/2"	75-1/2" X 99-1/2"	99-1/2" X 99-1/2"	99-1/2" X 123-1/2"
Net	Net	Net	Net
\$990.00	\$1,080.00	\$1,280.00	\$1,350.00

Adobe, Almond, Black, Bronze, Weathered Brown, White

WOODGUARD (3809)

Product line G3007 / G3012

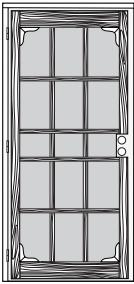

Single Door Standard Size

Size	List Price
2.06-6.08	\$710.00
2.08-6.08	\$710.00
3.00-6.08	\$810.00

Single Door Custom Size

Up to:	Up to:	Up to:	Up to:
39-1/2" X 83-1/2"	39-1/2" X 99-1/2"	51-1/2" X 99-1/2"	51-1/2" X 123-1/2"
Net	Net	Net	Net
\$810.00	\$840.00	\$870.00	\$910.00

Double Door Standard Size

Size	List Price
5.00-6.08	\$1,480.00
5.04-6.08	\$1,480.00
6.00-6.08	\$1,480.00

Double Door Custom Size

Up to:	Up to:	Up to:	Up to:
75-1/2" X 83-1/2"	75-1/2" X 99-1/2"	99-1/2" X 99-1/2"	99-1/2" X 123-1/2"
Net	Net	Net	Net
\$1,480.00	\$1,620.00	\$1,780.00	\$1,980.00

Adobe, Almond, Black, Bronze, Weathered Brown, White

ARIZONA

6875 Single / 7875 Double
Product line G3012



ABERDEEN

6830 Single / 7830 Double
Product line G3012



BEACON

6800 Single / 7800 Double
Product line G3012



CALYPSO

6833 Single / 7833 Double
Product line G3012



Single Door Standard Size

Size	List Price
2.06-6.08	\$1,080.00
2.08-6.08	\$1,080.00
3.00-6.08	\$1,080.00

Single Door Custom Size

Up to:	Up to:	Up to:	Up to:
39-1/2" X 83-1/2"	39-1/2" X 99-1/2"	51-1/2" X 99-1/2"	51-1/2" X 123-1/2"
Net	Net	Net	Net
\$1,080.00	\$1,290.00	\$1,590.00	\$1,720.00

Double Door Standard Size

Size	List Price
5.00-6.08	\$1,910.00
5.04-6.08	\$1,910.00
6.00-6.08	\$1,910.00

Double Door Custom Size

Up to:	Up to:	Up to:	Up to:
75-1/2" X 83-1/2"	75-1/2" X 99-1/2"	99-1/2" X 99-1/2"	99-1/2" X 123-1/2"
Net	Net	Net	Net
\$1,910.00	\$1,950.00	\$2,050.00	\$2,210.00

Adobe, Almond, Black, Bronze, Weathered Brown, White

PRICE LIST

EFFECTIVE: 9-1-2016

DECO

3842 Single / 5842 Double
Product line G3012



DYNASTY

6845 Single / 7845 Double
Product line G3012



ECLIPSE

6812 Single / 7812 Double
Product line G3012



FIORI

6840 Single / 7840 Double
Product line G3012



GEOTIC

6876 Single / 7876 Double
Product line G3012



LAVENDER

6809 Single / 7809 Double
Product line G3012



MONACO

6807 Single / 7807 Double
Product line G3012



NOUVEAU

6835 Single / 7835 Double
Product line G3012



PORTICO

6802 Single / 7802 Double
Product line G3012



SAN MARINO

3840 Single / 5840 Double
Product line G3012



SHERWOOD

6803 Single / 7803 Double
Product line G3012



STARFIRE

6801 Single / 7801 Double
Product line G3012

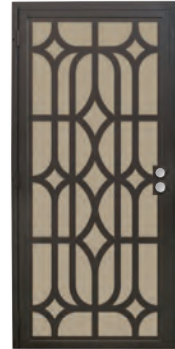

Single Door Standard Size

Size	List Price
2.06-6.08	\$1,080.00
2.08-6.08	\$1,080.00
3.00-6.08	\$1,080.00

Single Door Custom Size

Up to: 39-1/2" X 83-1/2" Net	Up to: 39-1/2" X 99-1/2" Net	Up to: 51-1/2" X 99-1/2" Net	Up to: 51-1/2" X 123-1/2" Net
\$1,080.00	\$1,290.00	\$1,590.00	\$1,720.00

Double Door Standard Size

Size	List Price
5.00-6.08	\$1,910.00
5.04-6.08	\$1,910.00
6.00-6.08	\$1,910.00

Double Door Custom Size

Up to: 75-1/2" X 83-1/2" Net	Up to: 75-1/2" X 99-1/2" Net	Up to: 99-1/2" X 99-1/2" Net	Up to: 99-1/2" X 123-1/2" Net
\$1,910.00	\$1,950.00	\$2,050.00	\$2,210.00

Adobe, Almond, Black, Bronze, Weathered Brown, White

Sec. 2 – VI

PRICE LIST

SOUTHWEST

3837 Single / 5837 Double
Product line G3012



STEPLOCK

6810 Single / 7810 Double
Product line G3012



SURREY

6839 Single / 7839 Double
Product line G3012



VICTORIAN

6806 Single / 7806 Double
Product line G3012



VINEYARD

3823 Single / 5823 Double
Product line G3012



VINEYARD FULL

3826 Single / 5826 Double
Product line G3012



Single Door Standard Size

Size	List Price
2.06-6.08	\$1,080.00
2.08-6.08	\$1,080.00
3.00-6.08	\$1,080.00

Single Door Custom Size

Up to: 39-1/2" X 83-1/2" Net	Up to: 39-1/2" X 99-1/2" Net	Up to: 51-1/2" X 99-1/2" Net	Up to: 51-1/2" X 123-1/2" Net
\$1,080.00	\$1,290.00	\$1,590.00	\$1,720.00

Double Door Standard Size

Size	List Price
5.00-6.08	\$1,910.00
5.04-6.08	\$1,910.00
6.00-6.08	\$1,910.00

Double Door Custom Size

Up to: 75-1/2" X 83-1/2" Net	Up to: 75-1/2" X 99-1/2" Net	Up to: 99-1/2" X 99-1/2" Net	Up to: 99-1/2" X 123-1/2" Net
\$1,910.00	\$1,950.00	\$2,050.00	\$2,210.00







Adobe, Almond, Black, Bronze, Weathered Brown, White

PRICE LIST

EFFECTIVE: 9-1-2016

REMOVABLE INSERT DESIGNS

For Vineyard, Paradise, Impressions & Longevity doors

	Description	Option Code	List Price
	Cactus	OP-Cactus	\$65.00
	Coyote	OP-Coyote	\$65.00
	Deer scene	OP-DeerScene	\$65.00
	Dolphins	OP-Dolphin	\$65.00
	Gecko	OP-Gecko	\$65.00
	Horse	OP-Horse	\$65.00

	Description	Option Code	List Price
	Humming bird Included standard with Paradise doors	OP-Hummingbird	\$65.00
	Longevity Included standard with Longevity doors	OP-Longevity	\$65.00
	Love birds	OP-Lovebirds	\$65.00
	Palm tree	OP-PalmTree	\$65.00
	Welcome Included standard with Impressions & Vineyard doors	OP-Welcome	\$65.00
	Whale tail	OP-Whaletail	\$65.00

Adobe, Almond, Black, Bronze, White

PRICE LIST

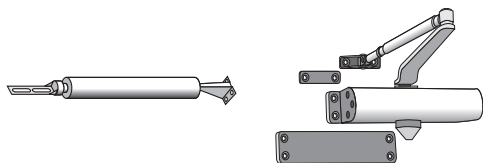

Option	Product Line	Description	List Price
2126BZ	F3970	Standard door closer, bronze	\$31.68
2126BK	F3970	Standard door closer, black	\$31.68
2127BK	G8002	Heavy duty closer, black	\$33.50
213007	G8002	Hydraulic door closer w/plates, gray only	\$111.00

Option	Option Code	Description	List Price
Mounting Variations (Refer to Page 47)	OP-SurfaceMt	Surface mount (standard)	\$0.00
	OP-InsetMt	Inset mount	\$39.22
	OP-InstMtTab	Inset mount w/tabs (specify tab size)	\$39.22
	OP-SurfMtTab	Surface mount w/tabs (specify tab size)	\$39.22
	OP-SMStdOffTab	Surface mount w/stand-off tabs (specify tab size)	\$39.22
	OP-SMTubeBack	Surface mount w/tube backing	\$54.04
	OP-IMFullStrap	Inset mount w/full strapping (specify strapping width)	\$77.74
	OP-IMSurfTab	Inset mount w/surface tabs (specify tab size)	\$101.32
Frame Variations	OP-3Piece	Three piece - door w/hinge bar, header bar, & strike bar (standard)	\$0.00
	OP-1Pc3Side1.25	One piece 3-sided 1-1/4" pre-hung frame	\$58.48
	OP-1Pc3Side1.5	One piece 3-sided 1-1/2" pre-hung frame	\$67.94
	OP-1Pc4Side1.25	One piece 4-sided 1-1/4" pre-hung frame	\$111.09
	OP-1Pc4Side1.5	One piece 4-sided 1-1/2" pre-hung frame	\$129.07
Double Door		Set-up (price of two custom doors and add:)	
	OP-DDCaneBolts	Double door w/cane-bolts (standard)	\$66.66
	OP-DDFlushBolts	Double door w/flush extension bolts in door stile	\$113.17
Lock-Box	OP-INSTL8560	Single hole lock-box	
	OP-RingGuard	Ring guard - welded	\$13.63
	OP-HandlePull	Handle pull	\$13.63
	OP-SpeclBLoc	Special lock-box location	\$59.25
Door Coverings	OP-24GaPerf	24 Ga. perforated steel mesh w/ 3/32" dia holes (standard)	\$0.00
	OP-ContPerf	Contrasting color perforated mesh	\$96.28
	OP-16GaExpnd	16 Ga. 1/2" expanded metal screen	\$0.00
	OP-13GaExpnd	13 Ga. 1/2" expanded metal screen	\$68.73
	OP-24GaSolid	24 Ga. solid sheet metal	\$312.50
	OP-HexPerfScreen-16	16 Ga. hexagon perforated steel mesh w/ screen	\$200.00
	OP-HexPerfScreen-22	22 Ga. hexagon perforated steel mesh w/ screen	\$150.00
	OP-NoPerf	No covering	\$0.00
Mail Slots	OP-MailSlitNoCvr	Cut-out, no cover (12" x 3" I.D.)	\$81.96
	OP-MailSlitWCvr	Cut-out, with cover (12" x 3" I.D.)	\$122.94
Pet Door Cut-Outs	OP-PD-CUTOUT-S	Cut-out for small pet door	\$51.79
	OP-PD-CUTOUT-M	Cut-out for medium pet door	\$61.21
	OP-PD-CUTOUT-L	Cut-out for large pet door	\$61.21
	OP-PD-CUTOUT-X	Cut-out for extra-large pet door	\$65.91
Pet Door Installed	OP-PD-STL-S	Cut-out and install small pet door	\$131.35
	OP-PD-STL-M	Cut-out and install medium pet door	\$173.02
	OP-PD-STL-L	Cut-out and install large pet door	\$215.18
	OP-PD-STL-X	Cut-out and install extra large pet door	\$327.13
Transoms (Up to 24" High)	OP-Trnsm-NoPerf	To doors with no perforated steel mesh	\$87.00
	OP-Trnsm-Perf	To doors with perforated steel mesh	\$211.00
	OP-Trnsm-Perf	To doors with expanded metal mesh	\$211.00
	OP-ArchedTop	Arched doors one piece pre-hung frame only - specify handing, provide template	\$310.00
Hydraulic Closer	OP-HydraulicClr	Hydraulic closer installed with mounting plates welded to frame & door	\$136.28
Primer	OP-Primerpaint	Primer undercoat + paint for extra rust protection	\$56.88

PRICE LIST

EFFECTIVE: 9-1-2016

CENTURION (3901)

Product line G3015

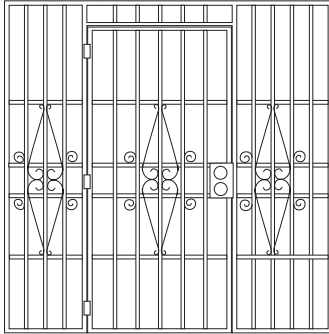

Up to: 84" x 96" 7'0" x 8'0"	Up to: 108" x 102" 9'0" x 8'6"	Up to: 132" x 102" 11'0" x 8'6"	Up to: 156" x 102" 13'0" x 8'6"	Up to: 180" x 108" 15'0" x 9'0"
Call for price	Call for price	Call for price	Call for price	Call for price

Adobe, Almond, Black, Bronze, White

KNIGHTGUARD (3902)

Product line G3015

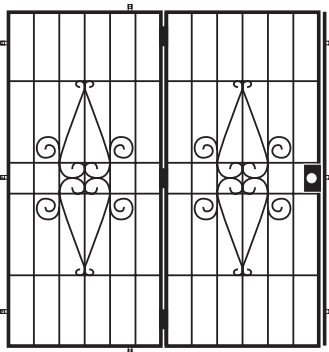

Up to: 61-1/2" x 80" 5'0" x 6'8"	Up to: 73-1/2" x 80" 6'0" x 6'8"	Up to: 97-1/2" x 80" 8'0" x 6'8"	Up to: 97-1/2" x 96" 8'0" x 8'0"	Up to: 121-1/2" x 96" 10'0" x 8'0"
\$630.00	\$660.00	\$680.00	\$740.00	\$840.00

Adobe, Almond, Black, Bronze, White

SENTINEL (3903)

Product line G3015

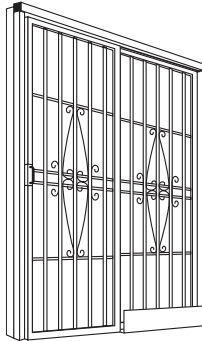

Up to: 61-1/2" x 82-1/2" 5'0" x 6'8"	Up to: 73-1/2" x 82-1/2" 6'0" x 6'8"	Up to: 97-1/2" x 82-1/2" 8'0" x 6'8"	Up to: 97-1/2" x 98-1/2" 8'0" x 8'0"	Up to: 121-1/2" x 98-1/2" 10'0" x 8'0"
\$940.00	\$990.00	\$1,080.00	\$1,150.00	\$1,350.00

Adobe, Almond, Black, Bronze, White

STEELMASTER (3904)

Product line G3015

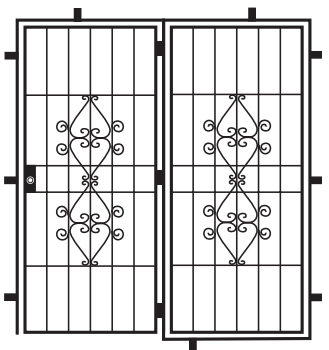

Up to: 61-1/2" x 82" 5'0" x 6'8"	Up to: 73-1/2" x 82" 6'0" x 6'8"	Up to: 97-1/2" x 82" 8'0" x 6'8"	Up to: 97-1/2" x 98" 8'0" x 8'0"	Up to: 121-1/2" x 98" 10'0" x 8'0"
\$1,480.00	\$1,520.00	\$1,580.00	\$1,630.00	Call for price

Adobe, Almond, Black, Bronze, White

PRICE LIST

STEEL PATIO DOORS & ENCLOSURES

Custom options (add-ons)

Product Line Z9999 for all options on this page

Option	Option Code	Description	List Price
Mounting Variations	OP-SurfaceMt	Surface mount (standard)	N/C
	OP-PDStdOffTab	Surface mount w/stand-off tabs (specify tab size)	N/C
	OP-PDSOTwStrap	Surface mount w/stand-off tabs & protective strap on lock side (specify tab size)	N/C
Lock-Box	OP-INSTL8560	Single hole lock-box	N/C
	OP-INSTL8559	Double hole lock-box	N/C
	OP-RingGuard	Ring guard - welded	\$13.63
	OP-HandlePull	Handle pull	\$13.63
	OP-SpecLBlOc	Special lock-box location	\$59.25
Door Coverings	OP-24GaPerf2SD	24 Ga. perforated steel mesh w/ 3/32" dia holes (both sides)	\$118.00
Door designs	OP-PDCarolina	Carolina style	\$223.50
	OP-PDDakota	Dakota style	\$216.00
	OP-PDGranada	Granada style	\$102.40
	OP-PDParadise	Paradise style (select insert)	\$228.64
	OP-PDImpression	Impressions style (select insert)	\$228.64
	OP-PDImperial	Imperial style	\$168.00
	OP-PDWoodguard	Woodguard style	\$204.00
	OP-PDClarion	Clarion style	\$260.00
	OP-PDSunburst	Sunburst style	\$220.00
OP-PDLongevity	Longevity style (select insert)	\$268.64	
Centurion Enclosure	OP-INSTL8560	Single hole lock-box	N/C
Steelmaster	OP-BOTHACTIVE	Both doors operable	\$370.31
Primer	OP-Primerpaint	Primer undercoat + paint for extra rust protection	\$56.88

PRICE LIST

EFFECTIVE: 9-1-2016

SERIES 450 WINDOW GUARD

Product line G3810

		Width									
		1'6"	2'0"	2'6"	3'0"	3'6"	4'0"	4'6"	5'0"	6'0"	8'0"
Height	1'6"	\$34.36	\$36.19	\$38.03	\$39.86	\$41.70	\$43.56	\$45.39	\$47.23	\$50.90	\$76.28
	2'0"	\$38.03	\$40.40	\$42.79	\$45.16	\$47.56	\$49.93	\$52.30	\$54.70	\$59.44	\$85.13
	2'6"	\$40.32	\$43.23	\$46.16	\$49.06	\$51.99	\$54.90	\$57.83	\$60.76	\$66.60	\$94.00
	3'0"	\$45.16	\$48.63	\$52.07	\$55.54	\$59.00	\$62.44	\$65.91	\$69.38	\$76.28	\$102.84
	3'6"	\$50.01	\$54.01	\$58.01	\$62.01	\$66.01	\$70.01	\$73.99	\$77.99	\$85.99	\$111.71
	4'0"	\$52.30	\$56.84	\$61.37	\$65.91	\$70.45	\$74.98	\$79.52	\$84.06	\$93.13	\$120.56
	4'6"	\$54.57	\$59.67	\$64.74	\$69.81	\$74.88	\$79.98	\$85.05	\$90.12	\$100.27	\$129.40
	5'0"	\$62.57	\$68.18	\$73.81	\$79.42	\$85.03	\$90.66	\$96.27	\$100.40	\$113.14	\$138.27
	6'0"	\$67.13	\$73.84	\$80.54	\$87.22	\$93.92	\$100.62	\$107.33	\$114.01	\$127.41	\$155.98

Almond, Black, Bronze, White

SERIES 455 WINDOW GUARD

Product line G3811

		Width									
		1'6"	2'0"	2'6"	3'0"	3'6"	4'0"	4'6"	5'0"	6'0"	8'0"
Height	1'6"	\$39.51	\$42.79	\$46.11	\$49.42	\$52.73	\$56.02	\$59.33	\$62.65	\$69.25	\$98.99
	2'0"	\$43.12	\$47.36	\$51.56	\$55.77	\$59.97	\$64.20	\$68.41	\$72.61	\$81.02	\$114.08
	2'6"	\$46.77	\$51.89	\$57.02	\$62.11	\$67.24	\$72.36	\$77.48	\$82.58	\$92.83	\$129.17
	3'0"	\$50.41	\$56.43	\$62.44	\$68.48	\$74.50	\$80.51	\$86.56	\$92.57	\$104.63	\$144.23
	3'6"	\$54.03	\$60.97	\$67.90	\$74.83	\$81.76	\$88.70	\$95.63	\$102.54	\$116.40	\$159.32
	4'0"	\$57.68	\$65.53	\$73.35	\$81.18	\$89.03	\$96.85	\$104.68	\$112.53	\$128.20	\$174.41
	4'6"	\$61.32	\$70.06	\$78.81	\$87.55	\$96.29	\$105.01	\$113.75	\$122.49	\$139.98	\$189.50
	5'0"	\$64.94	\$74.60	\$84.24	\$93.90	\$103.53	\$113.19	\$122.82	\$132.48	\$148.57	\$204.56
	6'0"	\$84.47	\$95.91	\$107.38	\$118.82	\$130.29	\$141.74	\$153.21	\$164.65	\$187.59	\$234.74

Almond, Black, Bronze, White

SERIES 460 WINDOW GUARD

Product line G3812

		Width									
		1'6"	2'0"	2'6"	3'0"	3'6"	4'0"	4'6"	5'0"	6'0"	8'0"
Height	1'6"	\$35.48	\$37.47	\$39.43	\$41.39	\$43.35	\$45.32	\$47.30	\$49.27	\$53.19	\$90.68
	2'0"	\$39.53	\$42.05	\$44.60	\$47.13	\$49.68	\$52.22	\$54.75	\$57.30	\$62.37	\$100.06
	2'6"	\$44.70	\$47.81	\$50.92	\$54.03	\$57.14	\$60.25	\$63.39	\$66.50	\$72.72	\$109.47
	3'0"	\$47.36	\$51.03	\$54.72	\$58.39	\$62.06	\$65.76	\$69.43	\$73.12	\$80.49	\$118.87
	3'6"	\$52.53	\$56.79	\$61.04	\$65.30	\$69.56	\$73.81	\$78.07	\$82.32	\$90.81	\$128.25
	4'0"	\$55.18	\$60.00	\$64.81	\$69.66	\$74.47	\$79.29	\$84.13	\$88.95	\$98.59	\$137.66
	4'6"	\$57.81	\$63.21	\$68.61	\$73.99	\$79.39	\$84.80	\$90.17	\$95.58	\$106.38	\$147.06
	5'0"	\$66.14	\$72.10	\$78.09	\$84.06	\$90.02	\$95.99	\$101.95	\$107.91	\$119.87	\$156.47
	6'0"	\$80.16	\$87.27	\$94.38	\$101.49	\$108.58	\$115.69	\$122.80	\$129.91	\$144.13	\$172.12

Almond, Black, Bronze, White

PRICE LIST

EFFECTIVE: 9-1-2016

WINDOW GUARD ACCESSORIES

Product line G8100

Part No.	Description	List Price
8100	3" Standard offset window guard bracket kit Pack consists of: 2 left hand, 2 right hand brackets and 4 each 5/16" x 3" one way lag screws.	\$26.49
8103	3" Standard center window guard bracket kit Pack consists of: 2 center brackets and 2 each 5/16" x 3" one way lag screws.	\$12.50
8106	Straight window guard bracket kit Pack consists of: 4 straight brackets and 4 each 5/16" x 3" one way lag screws.	\$36.00
8109	Flush window guard bracket kit Pack consists of: 2 left hand, 2 right hand flush brackets and 4 each 5/16" x 3" one way lag screws.	\$18.34
8111	Flush center - black (4 per) w/screws Pack consists of: 2 flush center guard brackets and 4 each 5/16" x 3" one way lag screws.	Call for price
8113	1" Offset window guard bracket kit Pack consists of: 2 left hand and 2 right hand brackets and 4 each 5/16" x 3" one way lag screws.	\$25.50
8115	6" Offset window guard bracket kit Pack consists of: 2 left hand and 2 right hand brackets and 4 each 5/16" x 3" one way lag screws.	
8116	Hinged center bracket Poly bag of 1 each; available in black.	\$7.48
8118	"T" bracket window guard kit Pack consists of: 2 "T" brackets and 2 each 5/16" x 3" one way lag screws.	\$5.25
8119	3" x 12" Offset window guard bracket kit	\$23.50

Hardware

8117	Fire release hinge bracket kit Pack consists of: 1 fire release bracket and 1 each 5/16" x 3" one way lag screws; available in almond, black and white.	\$32.00
8124	Fire release shielded cable kit Order lag screws separately; available in black and white.	\$134.08

Part No.	Pack QTY	Description	List Price
Tools			
8900	1	One way driving tool	\$21.00
8901	1	Adapter, used for 1/2" square drive	\$11.70
Fasteners Available in adobe, almond, black, bronze and white			
8130-2-4PK	4	5/16" x 2" lag screws	\$4.60
8130-3-4PK	4	5/16" x 3" lag screws	\$5.29
8130-4-4PK	4	5/16" x 4" lag screws	\$5.45
8130-2-100PK	100	5/16" x 2" lag screws	\$99.50
8130-3-100PK	100	5/16" x 3" lag screws	\$31.00
8130-4-100PK	100	5/16" x 4" lag screws	\$42.78

SECURITY MESH GUARD

Product line G3813

Part No.	Description	List Price
DG30	23-1/4" x 43", Fits 30" door	Call for price
DG32	25-1/4" x 43", Fits 32" door	Call for price
DG36	29-1/4" x 43", Fits 36" door	Call for price

MESH GUARD OPTIONS

Product line G3813

Part No.	Description	List Price
DG11	Stand-off tabs - additional	Call for price
DG100	1/2" Expanded metal (16 ga.)	Call for price
DG200	Perforated metal (24 ga.)	Call for price
DG300	Solid metal (24 ga.)	Call for price

PRICE LIST

EFFECTIVE: 9-1-2016

DEL SOL (3833)

Product line G3018

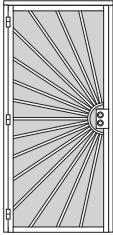

Size	List Price
2.08-6.08	\$235.00
3.00-6.08	\$165.00

Almond, Black, White

REGENT (3801)

Product line G3018

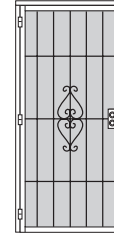

Size	List Price
2.08-6.08	\$181.00
3.00-6.08	

Black, Bronze, White

FLAGSTAFF (3853)

Product line G3018

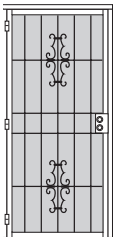

Size	List Price
2.06-6.08	\$325.00
3.00-6.08	\$209.00

Black, Bronze, White

SEDONA (3854)

Product line G3018

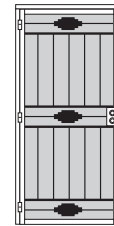

Size	List Price
2.08-6.08	\$277.00
3.00-6.08	\$235.00

Adobe, Almond

MONTERREY (3836)

Product line G3018



Size	List Price
3.00-6.08	\$205.00

Black, White

VALDOR (3832)

Product line G3018

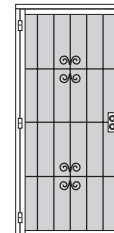

Size	List Price
3.00-6.08	\$99.00

Black, Bronze, White

ORLEANS (3851)

Product line G3018

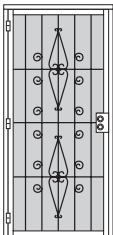

Size	List Price
2.08-6.08	\$168.00
3.00-6.08	

Black, White

WOODGUARD (3809-I)

Product line G3018



Size	List Price
2.08-6.08	\$265.00
3.00-6.08	

Bronze

REGAL (3818)

Product line G3018

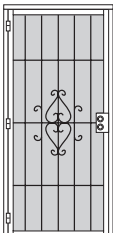

Size	List Price
2.06-6.08	\$105.00
2.08-6.08	
3.00-6.08	

Black, White

PRICE LIST

BRANSON (3751 ASSEMBLED)

Product line D3005

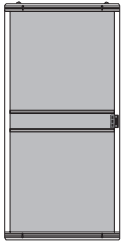

3751 (Assembled)

Standard sizes available	List Price
36"	\$92.00
48"	\$110.00

Bronze, Gray, White

BREEZEWAY (3700 ASSEMBLED)

Product line D3005

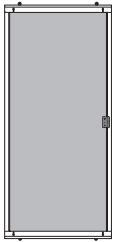

3700 (Assembled)

Standard sizes available	List Price
30"	\$74.00
36"	\$74.00
48"	\$82.00
60"	\$112.15

Bronze, Gray, White

BRENTWOOD (3100 ASSEMBLED / 4100 KD)

Product line D3301 / D3310

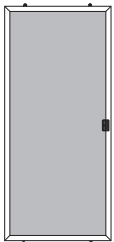

3100 (Assembled) | Product Line: D3301

Up to:	List Price	Up to:	List Price
37" x 81"	\$114.00	37" x 97"	\$126.00
49" x 81"	\$129.00	49" x 97"	\$139.00
61" x 81"	\$138.00	61" x 97"	\$147.00

Bronze, Gray, White

4100 (KD) | Product Line: D3310

Door size up to:	List Price	List Price	List Price
	6 Pack (price per door)	Single Door	Single - Standard Size Custom
31" x 81"	\$88.00	\$90.00	\$95.00
37" x 81"	\$91.00	\$93.00	\$98.00
43" x 81"	\$91.00	\$93.00	\$98.00
49" x 81"	\$93.00	\$95.00	\$100.00
61" x 81"	\$101.00	\$103.00	\$108.00
31" x 97"	\$93.00	\$95.00	\$100.00
37" x 97"	\$96.00	\$98.00	\$103.00
43" x 97"	N/A	\$98.00	Call for price
49" x 97"	\$98.00	\$100.00	\$105.00
61" x 97"	\$107.00	\$109.00	\$114.00
80" x 150"	Call for price	Call for price	\$135.00

Bronze, Gray, White

MAUI (3600 ASSEMBLED / 4600 KD)

Product line D3600



3600 (Assembled)

Up to:	List Price	Up to:	List Price
37" x 81"	\$138.00	37" x 97"	\$147.00
49" x 81"	\$154.00	49" x 97"	\$161.00
61" x 81"	\$169.00	61" x 97"	\$177.00

White

4600 (KD)

Door size up to:	List Price Single Door	List Price
		Single - Standard Size Custom
30" x 81"	\$127.00	\$132.00
36" x 81"	\$132.00	\$137.00
48" x 81"	\$139.00	\$144.00
60" x 81"	\$147.00	\$152.00
30" x 96"	\$131.00	\$136.00
36" x 96"	\$137.00	\$142.00
48" x 96"	\$146.00	\$151.00
60" x 96"	\$232.00	\$237.00
80" x 150"	\$270.00	\$275.00

White

PRICE LIST

EFFECTIVE: 9-1-2016

CLASSIC (3300 ASSEMBLED / 4300 KD)

Product line D3302 / D3311



3300 (Assembled) Product Line: D3302					
Up to:	List Price	Up to:	List Price	Up to:	List Price
37" x 81"	\$134.00	37" x 97"	\$146.00	37" x 110"	CALL FOR PRICING
49" x 81"	\$148.00	49" x 97"	\$157.00	49" x 110"	
61" x 81"	\$166.00	61" x 97"	\$166.00	61" x 110"	
73" x 81"		73" x 97"	\$203.00	73" x 110"	

Satin Anodized

3300 (Assembled) Product Line: D3302					
Up to:	List Price	Up to:	List Price	Up to:	List Price
37" x 81"	\$145.00	37" x 97"	\$158.00	37" x 110"	CALL FOR PRICING
49" x 81"	\$160.00	49" x 97"	\$170.00	49" x 110"	
61" x 81"	\$168.00	61" x 97"	\$180.00	61" x 110"	
73" x 81"	\$190.00	73" x 97"	\$220.00	73" x 110"	
				80" x 150"	\$300.00

Adobe, Almond, Black, Bronze, White, Bronze Anodized

4300 (KD) Product Line: D3311			
Door size up to:	List Price 6 Pack (price per door)	List Price Single Door	List Price Single - Standard Size Custom
31" x 81"	\$114.00	\$116.00	\$121.00
37" x 81"	\$113.00	\$115.00	\$120.00
43" x 81"	N/A	\$117.00	\$122.00
49" x 81"	\$120.00	\$122.00	\$127.00
61" x 81"	\$125.00	\$127.00	\$132.00
31" x 97"	N/A	\$123.00	\$128.00
37" x 97"	\$122.00	\$124.00	\$129.00
43" x 97"	N/A	\$125.00	\$130.00
49" x 97"	\$125.00	\$127.00	\$132.00
61" x 97"	\$128.00	\$130.00	\$135.00
31" x 110"			
37" x 110"			
43" x 110"			
49" x 110"			
61" x 110"			
80" x 150"			\$175.00

Satin Anodized

4300 (KD) Product Line: D3311			
Door size up to:	List Price 6 Pack (price per door)	List Price Single Door	List Price Single - Standard Size Custom
31" x 81"	\$120.00	\$122.00	\$127.00
37" x 81"	\$122.00	\$124.00	\$129.00
43" x 81"	\$125.00	\$127.00	\$132.00
49" x 81"	\$127.00	\$129.00	\$134.00
61" x 81"	\$124.00	\$126.00	\$131.00
31" x 97"	\$130.00*	\$132.00†	\$137.00‡
37" x 97"	\$130.00	\$132.00	\$137.00
43" x 97"	\$131.00	\$133.00	\$138.00
49" x 97"	\$133.00	\$135.00	\$140.00
61" x 97"	\$135.00	\$137.00	\$142.00
31" x 110"			
37" x 110"			
43" x 110"			
49" x 110"			
61" x 110"			
80" x 150"			\$175.00

Adobe, Almond, Black, Bronze, White

*Adobe and Black – N/A

†Adobe and Black – \$125.00

‡Adobe and Black – \$130.00

4300 (KD) Product Line: D3311			
Door size up to:	List Price 6 Pack (price per door)	List Price Single Door	List Price Single - Standard Size Custom
31" x 81"	\$122.00	\$124.00	\$129.00
37" x 81"	\$124.00	\$126.00	\$131.00
41" x 81"	\$132.00		
43" x 81"	\$132.00	\$129.00	\$134.00
49" x 81"	\$129.00	\$131.00	\$136.00
61" x 81"	\$126.00	\$128.00	\$133.00
31" x 97"	N/A	\$127.00	\$132.00
37" x 97"	\$132.00	\$134.00	\$139.00
43" x 97"	N/A	\$135.00	\$140.00
49" x 97"	\$135.00	\$137.00	\$142.00
61" x 97"	\$137.00	\$139.00	\$144.00
31" x 110"			
37" x 110"			
43" x 110"			
49" x 110"			
61" x 110"			
80" x 150"			\$175.00

Bronze Anodized

PRICE LIST

MARQUIS (3400 ASSEMBLED / 4400 KD)

Product line D3302 / D3312



3400 (Assembled) Product Line: D3302					
Up to:	List Price	Up to:	List Price	Up to:	List Price
37" x 81"	\$171.00	37" x 97"	\$184.00	37" x 110"	CALL FOR PRICING
49" x 81"	\$186.00	49" x 97"	\$201.00	49" x 110"	
61" x 81"	\$198.00	61" x 97"	\$220.00	61" x 110"	
73" x 81"	\$248.00	73" x 97"	\$261.00	73" x 110"	
60" x 120"	\$247.00	48" x 150"		80" x 150"	

Satin Anodized

3400 (Assembled) Product Line: D3302					
Up to:	List Price	Up to:	List Price	Up to:	List Price
37" x 81"	\$178.00	37" x 97"	\$191.00	37" x 110"	CALL FOR PRICING
49" x 81"	\$193.00	49" x 97"	\$208.00	49" x 110"	
61" x 81"	\$205.00	61" x 97"	\$227.00	61" x 110"	
73" x 81"	\$255.00	73" x 97"	\$268.00	73" x 110"	
60" x 120"	\$247.00	48" x 150"	\$280.00	80" x 150"	

Adobe, Almond, Black, Bronze, Bronze Anodized, White

4400 (KD) | Product Line: D3312

Door size up to:	List Price	List Price	List Price
	6 Pack (price per door)	Single Door	Single - Standard Size Custom
31" x 81"		\$134.00	\$139.00
37" x 81"		\$137.00	\$142.00
43" x 81"		\$141.00	\$146.00
49" x 81"		\$145.00	\$150.00
61" x 81"		\$152.00	\$157.00
31" x 97"		\$143.00	\$148.00
37" x 97"		\$146.00	\$151.00
43" x 97"		\$149.00	\$154.00
49" x 97"		\$154.00	\$159.00
61" x 97"		\$160.00	\$165.00
31" x 110"	CALL FOR PRICING		
37" x 110"			
43" x 110"			
49" x 110"			
61" x 110"			
80" x 150"			\$185.00

Satin Anodized

4400 (KD) | Product Line: D3312

Door size up to:	List Price	List Price	List Price
	6 Pack (price per door)	Single Door	Single - Standard Size Custom
31" x 81"	\$136.00*	\$138.00	\$143.00
37" x 81"		\$141.00	\$146.00
43" x 81"		\$145.00	\$150.00
49" x 81"		\$148.00	\$153.00
61" x 81"		\$153.00	\$158.00
31" x 97"		\$146.00	\$151.00
37" x 97"		\$150.00	\$155.00
43" x 97"		\$154.00 [†]	\$159.00 [‡]
49" x 97"		\$157.00	\$162.00
61" x 97"		\$163.00	\$168.00
31" x 110"	CALL FOR PRICING		
37" x 110"			
43" x 110"			
49" x 110"			
61" x 110"			
80" x 150"			\$185.00

Adobe, Almond, Black, Bronze, White

*White doors only
[†]Adobe – \$157.00
[‡]Adobe – \$162.00

4400 (KD) | Product Line: D3312

Door size up to:	List Price	List Price	List Price
	6 Pack (price per door)	Single Door	Single - Standard Size Custom
31" x 81"		\$140.00	\$145.00
37" x 81"		\$143.00	\$148.00
43" x 81"		\$147.00	\$152.00
49" x 81"		\$150.00	\$155.00
61" x 81"		\$155.00	\$160.00
31" x 97"		\$148.00	\$153.00
37" x 97"		\$152.00	\$157.00
43" x 97"		\$156.00	\$161.00
49" x 97"		\$159.00	\$164.00
61" x 97"		\$165.00	\$170.00
31" x 110"	CALL FOR PRICING		
37" x 110"			
43" x 110"			
49" x 110"			
61" x 110"			
80" x 150"			

Bronze Anodized

PRICE LIST

EFFECTIVE: 9-1-2016

PRESTIGE (3500 ASSEMBLED / 4500 KD)

Product line D3302 / D3312

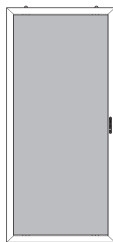

3500 (Assembled) Product Line: D3302			
Door size up to:	List Price	List Price	List Price
37" x 81"	\$218.00	\$225.00	\$225.00
49" x 81"	\$228.00	\$236.00	\$255.00
61" x 81"	\$233.00	\$240.00	
73" x 81"	\$257.00		
37" x 97"	\$221.00	\$228.00	\$228.00
49" x 97"	\$234.00	\$242.00	\$265.00
61" x 97"	\$251.00	\$260.00	
73" x 97"	\$261.00		
37" x 110"	CALL FOR PRICING		
49" x 110"			
61" x 110"			
73" x 110"			
72" x 120"	\$313.00	\$320.00	\$320.00
Finish:	Satin Anodized	Adobe, Almond, Black, Bronze, White	Bronze Anodized

4500 (KD) Product Line: D3312						
Door size up to:	List Price Single Door	List Price		List Price		List Price Single - Standard Size Custom
		Single - Standard	Size Custom	Single - Standard	Size Custom	
31" x 81"	\$140.00	\$145.00	\$160.00	\$165.00	\$181.00	\$186.00
37" x 81"	\$145.00	\$150.00	\$164.00	\$169.00	\$187.00	\$192.00
43" x 81"	\$149.00	\$154.00	\$169.00	\$174.00	\$193.00	\$198.00
49" x 81"	\$154.00	\$159.00	\$173.00	\$178.00	\$199.00	\$204.00
61" x 81"	\$160.00	\$165.00	\$182.00	\$187.00	\$211.00	\$216.00
31" x 97"	\$170.00	\$175.00	\$177.00	\$182.00	\$207.00	\$212.00
37" x 97"	\$175.00	\$180.00	\$182.00	\$187.00	\$213.00	\$218.00
43" x 97"	\$180.00	\$185.00	\$186.00	\$191.00	\$219.00	\$224.00
49" x 97"	\$185.00	\$190.00	\$191.00	\$196.00	\$225.00	\$230.00
61" x 97"	\$190.00	\$195.00	\$199.00	\$204.00	\$237.00	\$242.00
73" x 97"	\$195.00	\$200.00	\$209.00	\$214.00	\$248.00	\$253.00
31" x 110"	CALL FOR PRICING					
37" x 110"						
43" x 110"						
49" x 110"						
61" x 110"						
80" x 150"		\$223.00		\$235.00		\$288.00
Finish:	Satin Anodized		Adobe, Almond, Black, Bronze, White		Bronze Anodized	

PRICE LIST

EFFECTIVE: 9-1-2016

REGAL (3200 ASSEMBLED / 4200 KD)

Product line D3302 / D3311



3200 (Assembled) Product Line: D3302					
Up to:	List Price	Up to:	List Price	Up to:	List Price
37" x 81"	\$132.00	37" x 97"	\$145.00	37" x 110"	CALL FOR PRICING
49" x 81"	\$149.00	49" x 97"	\$159.00	49" x 110"	
61" x 81"	\$157.00	61" x 97"	\$169.00	61" x 110"	
73" x 81"	\$172.00	73" x 97"	\$182.00	73" x 110"	
60" x 120"	\$290.00	80" x 150"			

Satin Anodized

3200 (Assembled) Product Line: D3302					
Up to:	List Price	Up to:	List Price	Up to:	List Price
37" x 81"	\$141.00	37" x 97"	\$154.00	37" x 110"	CALL FOR PRICING
49" x 81"	\$158.00	49" x 97"	\$168.00	49" x 110"	
61" x 81"	\$166.00	61" x 97"	\$178.00	61" x 110"	
73" x 81"	\$181.00	73" x 97"	\$191.00	73" x 110"	
60" x 120"		80" x 150"	\$290.00		

Adobe, Almond, Black, Bronze, White

4200 (KD) Product Line: D3311			
Door size up to:	List Price 6 Pack (price per door)	List Price Single Door	List Price Single - Standard Size Custom
31" x 81"		\$75.00	
37" x 81"		\$77.00	
43" x 81"		\$79.00	
49" x 81"		\$81.00	
61" x 81"		\$86.00	
31" x 97"		\$80.00	
37" x 97"		\$80.00	
43" x 97"		\$83.00	
49" x 97"		\$88.00	
61" x 97"		\$92.00	
31" x 110"			
37" x 110"			
43" x 110"			
49" x 110"			
61" x 110"			
80" x 150"			\$143.00

Mill

CALL FOR PRICING

4200 (KD) Product Line: D3311									
Door size up to:	List Price 6 Pack (price per door)	List Price Single Door	List Price Single - Standard Size Custom	List Price 6 Pack (price per door)	List Price Single Door	List Price Single - Standard Size Custom	List Price 6 Pack (price per door)	List Price Single Door	List Price Single - Standard Size Custom
31" x 81"	\$100.00	\$102.00	\$107.00	\$108.00	\$110.00	\$115.00	N/A	\$112.00	\$118.00
37" x 81"	\$103.00	\$105.00	\$110.00	\$111.00	\$113.00	\$118.00	\$113.00	\$115.00	\$120.00
43" x 81"	\$108.00	\$110.00	\$110.00	\$114.00	\$116.00	\$121.00	N/A	\$118.00	\$123.00
49" x 81"	\$106.00	\$108.00	\$113.00	\$117.00	\$119.00	\$124.00	\$119.00	\$121.00	\$126.00
61" x 81"	\$111.00	\$113.00	\$118.00	\$123.00	\$125.00	\$130.00	\$125.00	\$127.00	\$132.00
31" x 97"	\$105.00	\$107.00	\$112.00	\$116.00	\$118.00	\$123.00	N/A	\$120.00	\$125.00
37" x 97"	\$108.00	\$110.00	\$115.00	\$119.00	\$121.00	\$126.00	\$121.00	\$123.00	\$128.00
43" x 97"	N/A	\$112.00	\$117.00	N/A	\$124.00	\$129.00	N/A	\$126.00	\$131.00
49" x 97"	\$114.00	\$116.00	\$121.00	\$125.00	\$127.00	\$132.00	\$127.00	\$129.00	\$134.00
61" x 97"	\$118.00	\$120.00	\$125.00	\$131.00	\$133.00	\$138.00	\$133.00	\$135.00	\$140.00
31" x 110"									
37" x 110"									
43" x 110"									
49" x 110"									
61" x 110"									
80" x 150"			\$143.00			\$165.00			\$167.00
Finish:	Satin Anodized			Adobe, Almond, Black, Bronze, White			Bronze Anodized		

CALL FOR PRICING

PRICE LIST

EFFECTIVE: 9-1-2016

CUSTOM OPTIONS

Option	Option Code	Product Line	Description	List Price
Door frame options	OP-1PB-1	D9999	Install 1 each #288PB – 1-1/8" extruded push bar	\$11.85
	OP-1PB-2	D9999	Install 2 each #288PB – 1-1/8" extruded push bar	\$23.70
	OP-CRNSCR		Install 4 screws in each corner; total 16 screws	\$12.00
	OP-NOSLOT-HARDW		No latch, handles, rollers; no punch or slotting	N/C
	OP-SLSLOT4HNDL		Sliding door handle height; punch XX-x/x" up from bottom to	N/C
Roller options	OP-CLASSIC-N		Install classic side adjust nylon rollers (#477002N)	N/C
	OP-MARQUIS-NB		Slot & install Marquis nylon ball bearing rollers bottom (#4828N)	\$3.56
	OP-MARQUIS-NT		Slot & install Marquis nylon ball bearing rollers top (#4830)	\$3.00
	OP-MARQUIS-NTB		Slot & install Marquis nylon ball bearing rollers top & bottom (#4830 & #4828N)	\$6.00
	OP-MARQUIS-SB		Slot & install Marquis steel ball bearing rollers bottom (#4828)	\$3.56
	OP-MARQUIS-ST		Slot & install Marquis steel ball bearing rollers top (#4830)	\$3.00
	OP-MARQUIS-STB		Slot & install Marquis steel ball bearing rollers top & bottom (#4830 & #4828)	\$6.00
	OP-MARQUIS-SSB		Slot & install Marquis stainless steel ball bearing rollers bottom (#4828SS)	\$14.81
	OP-MARQUIS-SST		Slot & install Marquis stainless steel ball bearing rollers top (#4830SS)	\$14.81
	OP-MARQUIS-SSTB		Slot & install marquis stainless steel ball bearing rollers top & bottom (#4830SS & #4828SS)	\$29.63
	OP-REGAL-S		Install Regal steel rollers top & bottom #4131	\$5.46
	OP-REGAL-SS		Install Regal stainless steel ball bearing rollers #4131-SS	\$29.63
Handing options	OP-HNDLLEFT		XO"" Handle left from the outside looking in	\$0.00
	OP-HNDLRIGHT		OX"" Handle right from the outside looking in	\$0.00
Handle options	OP-1HNDL4227		Install Anjac handle #4227	\$4.99
	OP-2HNDL4227		Install Anjac handle #4227	\$4.99
	OP-1HNDL4230		Install Superior handle #4230	\$17.78
	OP-1HNDL4736		Install latch & flush handle inside & out #4736 w/latch	\$4.99
	OP-1HNDL4736-NS		No slot/no latch, install flush handles inside & out #4736	\$15.00
Grille options	OP-GREMPRESS-30		Install Empress heavy duty grille 30"	\$66.36
	OP-GREMPRESS-36		Install Empress heavy duty grille 36"	\$68.73
	OP-GREMPRESS-48		Install Empress heavy duty grille 48"	\$81.77
	OP-GREMPRESS-60		Install Empress heavy duty grille 60"	\$95.99
	OP-GRFIESTA-30		Install Fiesta grille 30"	\$58.66
	OP-GRFIESTA-36		Install Fiesta grille 36"	\$64.58
	OP-GRFIESTA-48		Install Fiesta grille 48"	\$74.06
	OP-GRFIESTA-60		Install Fiesta grille 60"	\$85.91

CUSTOM OPTIONS

Option	Option Code	Product Line	Description	List Price
Pet door options	OP-PD-SLD-S		Install pet door handle side – small w/adapter	\$177.75
	OP-PD-SLD-M		Install pet door handle side – medium w/adapter	\$241.74
	OP-PD-SLD-L		Install pet door handle side – large w/adapter	\$310.47
Pet door colors	OP-AD		Adobe	Call for price
	OP-AL		Almond	Call for price
	OP-BZ		Bronze	Call for price
	OP-SA		Satin anodized	Call for price
	OP-WH		White	Call for price
Screen cloth options	OP-SC14CF		Screen cloth charcoal fiber 18" x 14"	\$0.24 / sq. ft.
	OP-SC14GF		Screen cloth gray fiber 18" x 14"	\$0.24 / sq. ft.
	OP-SC16BA		Screen cloth brite aluminum 18" x 16"	\$0.38 / sq. ft.
	OP-SC16BV		Screen cloth better vue	\$0.302 / sq. ft.
	OP-SC16CA		Screen cloth charcoal aluminum 18" x 16"	\$0.45 / sq. ft.
	OP-SC16CF		Screen cloth charcoal fiber 18" x 16"	N/C
	OP-SC16GF		Screen cloth gray fiber 18" x 16"	N/C
	OP-SC16UV		Screen cloth ultra vue	\$0.62 / sq. ft.
	OP-SC20CF		Screen cloth charcoal fiber 20" x 20"	\$0.52 / sq. ft.
	OP-SCD		Delete screen cloth & spline; door shell only	N/C
	OP-SCPSBK		Screen cloth black petscreen	\$1.64 / sq. ft.
	OP-SCPSLBK		Screen cloth black petscreen lite	\$1.04 / sq. ft.
	OP-SCPSGR		Screen cloth gray petscreen	\$1.64 / sq. ft.
	OP-SCSSCF		Screen cloth charcoal sunscreen	\$1.30 / sq. ft.
	OP-SCSSGF		Screen cloth gray sunscreen	\$1.10 / sq. ft.
	OP-SCSTBK		Screen cloth black sun tex 80%	\$1.75 / sq. ft.
	OP-SCSTBR		Screen cloth brown sun tex 80%	\$1.75 / sq. ft.
	OP-SCSTGR		Screen cloth gray sun tex 80%	\$1.48 / sq. ft.
	OP-SCSTST		Screen cloth stucco sun tex 80%	\$1.75 / sq. ft.

TOP HUNG UNIVERSAL MOUNTING CHANNEL (4848)

Product line F3870

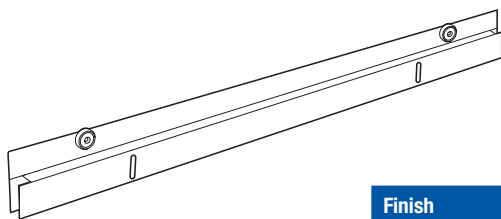

Finish	Size - (36")	List Price	Size - (48")	List Price
Adobe	4848AD-36	Call for price	4848AD-48	Call for price
Almond	4848AL-36	Call for price	4848AL-48	Call for price
Bronze	4848BZ-36	\$32.39	4848BZ-48	\$44.55
Satin Anodized	4848SA-36	Call for price	4848SA-48	Call for price
White	4848WH-36	\$32.39	4848WH-48	\$44.55

PRICE LIST

EFFECTIVE: 9-1-2016

SLIDING SCREEN COMPONENTS

Color code chart (xx)

AD = Adobe	BK = Black	ML = Mill
AL = Almond	BZ = Bronze	SA = Satin anodized
BA = Bronze anodized	GR = Gray	WH = White

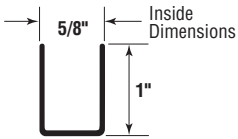
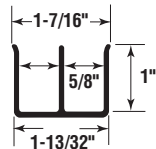
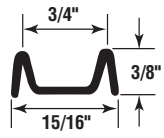
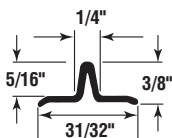
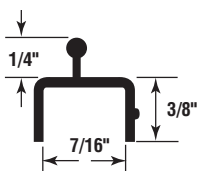
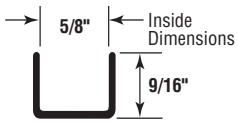
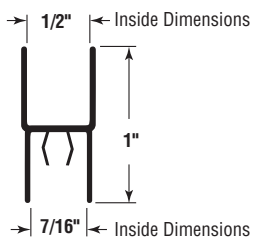
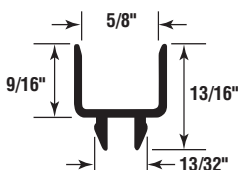
Part No.	Product Line	Description	Drawing	List Price
4180xx	F3874	5/8" x 1" Top single track 12' (Available in all colors except gray)		\$36.00
4181xx	F3874	5/8" x 1" Top double track 12' (Available in all colors except gray)		\$46.00
4184xx	F3874	Bottom double track 12' (Available in all colors except gray)		\$28.00
4185xx	F3874	Single bottom track 12' (Available in all colors except gray)		AD - \$28.00 AL - \$28.00 BA - \$28.00 BK - \$28.00 BZ - \$28.00 ML - \$24.50 SA - \$28.00 WH - \$28.00
4189WH-6 4189WH-8 4189WH	F3870 F3870 F3870	Extruded vinyl track 6' Extruded vinyl track 8' Extruded vinyl track 16' (Available in white only)		6 ft. - \$10.88 8 ft. - \$14.69 16 ft. - \$28.10
4195xx	F3874	5/8" x 1/2" Top single track 12' (Available in all colors except gray)		\$24.00
4198xx-84 4198BK-96 4198xx-100	F3874 F3874 F3874	Rigid vinyl astragal - 84" (all available colors) Rigid vinyl astragal - 96" (black only) Rigid vinyl astragal - 100" (AL not available) (Available colors: AD, AL, BK, BZ, GR & WH)		84 in. - \$15.00 96 in. - Call for price 100 in. - Call for price
4199xx84 4199xx 4199xx-120	F3874 F3874	Used for extruded sliders Extruded screen astragal - 7' Extruded screen astragal - 8' Extruded screen astragal - 10' (Available in all colors except gray)		7 ft. (AL, BA, BK, BZ, SA) - \$13.00 7 ft. (WH) - \$19.00 8 ft. - \$16.00 10 ft. - \$19.00

PRICE LIST

EFFECTIVE: 9-1-2016

DOGWOOD (3950)

Product line D3025

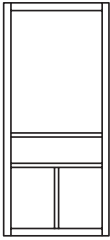

Size	List Price
2.06-6.08	\$65.00
2.08-6.08	
3.00-6.08	

Natural

MAGNOLIA (3670N)

Product line D3610

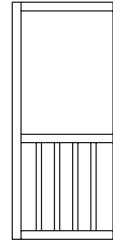

Size	List Price
2.08-6.08	\$160.00
3.00-6.08	

White

ASPEN (3951)

Product line D3025

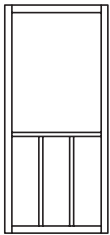

Size	List Price
2.06-6.08	\$75.00
2.08-6.08	
3.00-6.08	

Natural

VERMONT (3671N)

Product line D3610

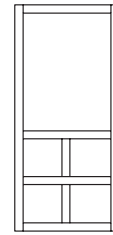

Size	List Price
3.00-6.08	\$166.00

White

NANTUCKET (3952)

Product line D3025

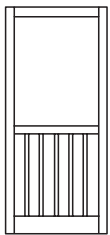

Size	List Price
2.08-6.08	\$127.00
3.00-6.08	

Natural

9 PANEL (3942)

Product line D3025

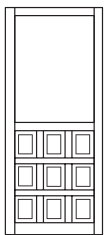

Size	List Price
2.08-6.08	\$95.00
3.00-6.08	

Natural

PRICE LIST

CLARION (3906)

Product line G3012

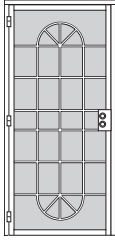

Size	List Price
2.06-6.08	\$850.00
2.08-6.08	
3.00-6.08	

Adobe, Almond, Black, Bronze, Weathered Brown, White

IMPERIAL (3905)

Product line G3012



Size	List Price
2.08-6.08	Call for price
3.00-6.08	

Adobe, Almond, Black, Bronze, Weathered Brown, White

CAROLINA (3907)

Product line G3012

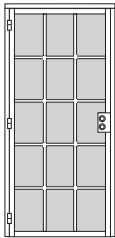

Size	List Price
2.06-6.08	Call for price
2.08-6.08	
3.00-6.08	

Adobe, Almond, Black, Bronze, Weathered Brown, White

STEEL STORM DOORS

Custom options (add-ons)

Option	Option Code	Description	List Price
Mounting Variations (Refer to Page 81)	OP-SurfaceMt	Surface mount (standard)	\$0.00
	OP-InsetMt	Inset mount	\$39.22
	OP-InstMtTab	Inset mount w/tabs (specify tab size)	\$39.22
	OP-SurfMtTab	Surface mount w/tabs (specify tab size)	\$39.22
	OP-SMSndOffTab	Surface mount w/stand-off tabs (1-1/2" = OP-53 or 2" = OP-542)	\$39.22
	OP-SMTubeBack	Surface mount w/tube backing	\$54.04
	OP-IMFullStrap	Inset mount w/full strapping (specify strapping width)	\$77.74
	OP-IMSurfTab	Inset mount w/surface tabs (specify tab size)	\$101.32
Frame Variations	OP-1Pc3Side	One piece 3-sided pre-hung frame (standard)	\$58.48
	OP-1Pc4Side	One piece 4-sided pre-hung frame	\$67.94
Double Door	OP-DDFlushBolts	Set-up (price of two custom doors and add:) Double door w/flush extension bolts in door stile	\$113.17
Hardware	OP-SpecLBOc	Special lock-box location	\$59.25
Door Coverings	OP-24GaPerf	Removable 24 Ga. perforated steel mesh w/ 3/32" dia holes (specify color)	\$0.00
Hydraulic Closer	OP-HydraulicClr	Hydraulic closer installed with mounting plates welded to frame & door	\$136.28

SWINGING SCREEN DOOR GRILLES

FIESTA 27" (.090 THICK PATTERN)

Product line F3316

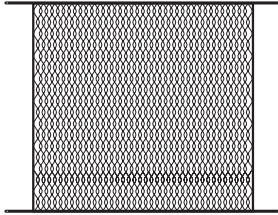

Part No.	Description	List Price
2380xx	30" Swinging door grille	\$44.00
2381xx	32" Swinging door grille	\$45.00
2382xx	36" Swinging door grille	\$50.00
2383xx	42" Swinging door grille	\$53.00

Color code chart (xx)	
AD = Adobe	ML = Mill
AL = Almond	WH = White
BZ = Bronze	

EMPRESS 27" (.125 THICK PATTERN)

Product line F3316

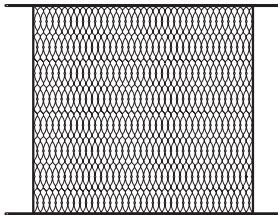

Part No.	Description	List Price
2390xx	30" Swinging door grille	\$49.00
2391xx	32" Swinging door grille	\$54.00
2392xx	36" Swinging door grille	\$54.00
2393xx	42" Swinging door grille	\$59.00

SWINGING DOOR GRILLE NET SIZES

For Fiesta & Empress grilles

Nominal size	Actual tip to tip	Actual body size
30" x 27"	29"	25" x 27-1/4"
32" x 27"	31"	27" x 27-1/4"
36" x 27"	35"	31" x 27-1/4"
42" x 27"	41"	37" x 27-1/4"

SLIDING SCREEN DOOR GRILLES

FIESTA 33" (.090 THICK PATTERN)

Product line F3316

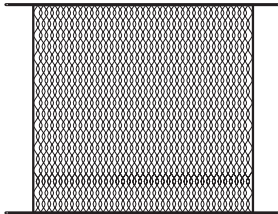

Part No.	Description	List Price
2384xx	30" Sliding door grille	\$48.00
2385xx	36" Sliding door grille	\$54.00
2386xx	42" Sliding door grille	\$63.00
2387xx	48" Sliding door grille	\$68.00
2388xx	60" Sliding door grille	\$72.00

Color code chart (xx)	
AD = Adobe	ML = Mill
AL = Almond	WH = White
BZ = Bronze	

EMPRESS 33" (.125 THICK PATTERN)

Product line F3316

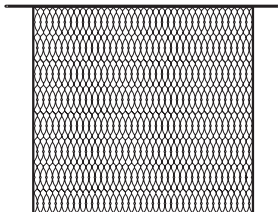

Part No.	Description	List Price
2394xx	30" Sliding door grille	\$52.00
2395xx	36" Sliding door grille	\$58.00
2397xx	48" Sliding door grille	\$73.00
2398xx	60" Sliding door grille	\$79.00

SLIDING DOOR GRILLE NET SIZES

For Fiesta & Empress grilles

Nominal size	Actual tip to tip	Actual body size
30" x 33"	30"	26" x 33-1/8"
36" x 33"	36"	32" x 33-1/8"
48" x 33"	48"	44" x 33-1/8"
60" x 33"	60"	56" x 33-1/8"

PRICE LIST

EFFECTIVE: 9-1-2016

CUSTOM MADE DOOR GRILLES

Color code chart (xx)

AD = Adobe	ML = Mill
AL = Almond	WH = White
BZ = Bronze	

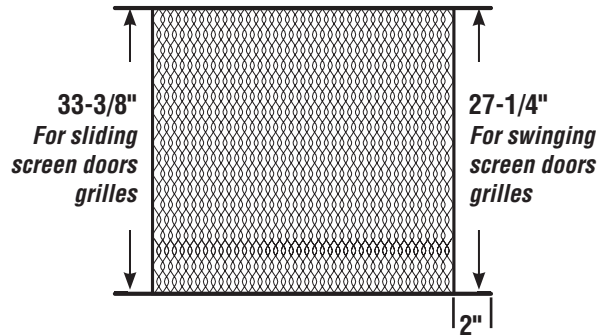

FIESTA (.090 THICK PATTERN)

Product line F3316

Part No.	Description		List Price
	Tip To Tip	No Tips	
2389xx	To 34" x 27"	To 31" x 27"	\$55.00
2389xx	To 36" x 33"	To 32" x 33"	\$65.00
2389xx	To 48" x 33"	To 44" x 33"	\$70.00
2389xx	To 60" x 33"	To 56" x 33"	\$80.00

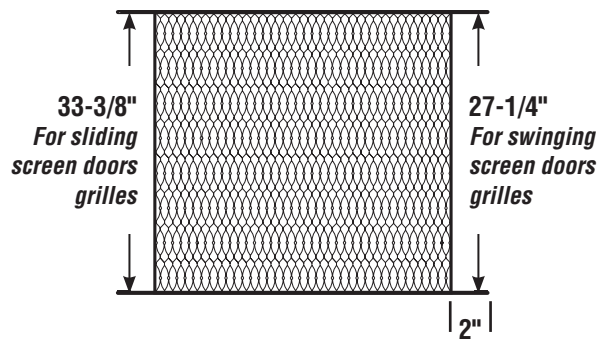

EMPRESS (.125 THICK PATTERN)

Product line F3316





Part No.	Description		List Price
	Tip To Tip	No Tips	
2399xx	To 34" x 27"	To 31" x 27"	\$60.00
2399xx	To 36" x 33"	To 32" x 33"	\$70.00
2399xx	To 48" x 33"	To 44" x 33"	\$80.00
2399xx	To 60" x 33"	To 56" x 33"	\$90.00

PRICE LIST

PET ACCESSORIES

Product line F3900

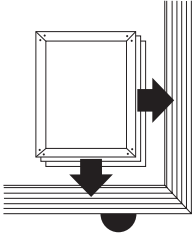
Color code chart (xx)
AD = Adobe
AL = Tan (Almond)
BZ = Bronze
BK = Black
SA = Satin
WH = White



	Part No.	List Price
	2186BZ	\$35.00
	2187R 2188R 2189R 2190R	\$83.00 \$49.00 \$82.00 \$103.00
	2187xx 2188xx 2189xx 2190xx	\$83.00 \$114.00 \$153.00 \$206.00
	2203xx 2204xx 2205xx 2206xx	\$39.10 \$44.85 \$54.05 \$92.00
	2193xx 2194xx 2195xx	\$256.00 \$309.00 \$369.00

PRICE LIST

EFFECTIVE: 9-1-2016

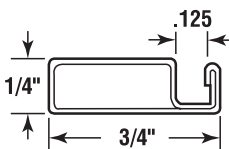

1/4" ALUMINUM SCREEN FRAME & CORNERS

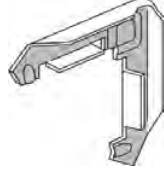
Product line A1000 / D1110 / D1111

SER-123	Part No.	Unit of Measurement	List Price
3/4" x 1/4" Screen frame 	123ML122-BX	LF1	\$0.59
	123BZ122-BX	LF1	\$0.59
	123WH122-BX	LF1	\$0.59
	123ML122-BN	LF1	\$0.59
	123BZ122-BN	LF1	\$0.59
	123WH122-BN	LF1	\$0.59
	123ML122-PK	LF1	\$0.64
	123BZ122-PK	LF1	\$0.67
	123WH122-PK	LF1	\$0.67
	3/4" x 1/4" Plastic corner 	C123GR	EA1
C123BZ		EA1	\$0.27
C123WH		EA1	\$0.27
3/4" x 1/4" Miter cut corner 	C123ML-035	EA1	\$0.20

5/16" ALUMINUM SCREEN FRAME & CORNERS

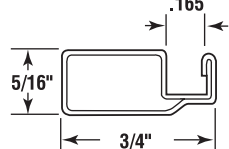
Product line A1099 / D1199



SER-520	Part No.	Unit of Measurement	List Price	
3/4" x 5/16" Screen frame 	520ML122-BX	FT	\$0.53	
	520GR122-BX	FT	\$0.53	
	520BZ122-BX	FT	\$0.53	
	520WH122-BX	FT	\$0.53	
	520AL122-BX	FT	\$0.53	
	520AD122-BX	FT	\$0.53	
	520ML122-BN	FT	\$0.55	
	520GR122-BN	FT	\$0.55	
	520BZ122-BN	FT	\$0.55	
	520WH122-BN	FT	\$0.55	
	520AL122-BN	FT	\$0.55	
	520AD122-BN	FT	\$0.55	
	520ML122-PK	FT	\$0.56	
	520GR122-PK	FT	\$0.56	
	520BZ122-PK	FT	\$0.56	
	520WH122-PK	FT	\$0.56	
	520AL122-PK	FT	\$0.56	
	520AD122-PK	FT	\$0.56	
	3/4" x 5/16" Plastic corner 	C520GR	EA1	\$0.27
		C520BZ	EA1	\$0.27
C520WH		EA1	\$0.27	
C520AL				
3/4" x 5/16" Miter cut corner 	C520ML-040	EA1	\$0.21	

PRICE LIST

EFFECTIVE: 9-1-2016

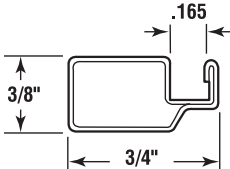

3/8" ALUMINUM SCREEN FRAME & CORNERS

Product line A1099 / D1111 / D1199

SER-519	Part No.	Unit of Measurement	List Price
 <p>SER-119 = .020 SER-119E = .018 SER-119H = .025</p>	519ML122-BX	FT	\$0.50
	519GR122-BX	FT	\$0.50
	519BZ122-BX	FT	\$0.50
	519WH122-BX	FT	\$0.50
	519AL122-BX	FT	\$0.50
	519AD122-BX	FT	\$0.50
	519ML122-BN	FT	\$0.53
	519GR122-BN	FT	\$0.53
	519BZ122-BN	FT	\$0.53
	519WH122-BN	FT	\$0.53
	519AL122-BN	FT	\$0.53
	519AD122-BN	FT	\$0.53
	519ML122-PK	FT	\$0.57
	519GR122-PK	FT	\$0.57
	519BZ122-PK	FT	\$0.57
	519WH122-PK	FT	\$0.57
	519AL122-PK	FT	\$0.57
	519AD122-PK	FT	\$0.57
	519ML122H-BX	FT	\$0.57
	519GR122H-BX	FT	\$0.57
	519BZ122H-BX	FT	\$0.57
	519WH122H-BX	FT	\$0.57
	519ML122H-BN	FT	\$0.59
	519GR122H-BN	FT	\$0.59
	519BZ122H-BN	FT	\$0.59
	519WH122H-BN	FT	\$0.59
	519ML122H-PK	FT	\$0.63
	519GR122H-PK	FT	\$0.63
519BZ122H-PK	FT	\$0.63	
519WH122H-PK	FT	\$0.63	
	C119GR	EA1	\$0.27
	C119BZ	EA1	\$0.27
	C119WH	EA1	\$0.27
	C119AL	EA1	\$0.27
	C519ML-050	EA1	\$0.22

7/16" ALUMINUM SCREEN FRAME & CORNERS

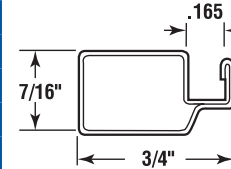
Product line A1099 / D1110 / D1111



SER-516	Part No.	Unit of Measurement	List Price
 <p>SER-115 = .025 SER-116 = .020 SER-116E = .018</p>	516ML122-BX	FT	\$0.55
	516GR122-BX	FT	\$0.55
	516BZ122-BX	FT	\$0.55
	516WH122-BX	FT	\$0.55
	516AL122-BX	FT	\$0.55
	516AD122-BX	FT	\$0.55
	516ML122-BN	FT	\$0.59
	516GR122-BN	FT	\$0.59
	516BZ122-BN	FT	\$0.59
	516WH122-BN	FT	\$0.59
	516AL122-BN	FT	\$0.59
	516AD122-BN	FT	\$0.59
	516ML122-PK	FT	\$0.63
	516GR122-PK	FT	\$0.63
	516BZ122-PK	FT	\$0.63
	516WH122-PK	FT	\$0.63
	516AL122-PK	FT	\$0.63
	516AD122-PK	FT	\$0.63
	515ML122-BX	FT	\$0.75
	515GR122-BX	FT	\$0.75
	515BZ122-BX	FT	\$0.75
	515WH122-BX	FT	\$0.75
	515AL122-BX	FT	\$0.75
	515AD122-BX	FT	\$0.75
	515ML122-BN	FT	\$0.77
	515GR122-BN	FT	\$0.77
	515BZ122-BN	FT	\$0.77
	515WH122-BN	FT	\$0.77
	515AL122-BN	FT	\$0.77
	515AD122-BN	FT	\$0.77
	515ML122-PK	FT	\$0.79
	515GR122-PK	FT	\$0.79
515BZ122-PK	FT	\$0.79	
515WH122-PK	FT	\$0.79	
515AL122-PK	FT	\$0.79	
515AD122-PK	FT	\$0.79	
	C116GR	EA1	\$0.27
	C116BZ	EA1	\$0.27
	C116WH	EA1	\$0.27
	C116AL	EA1	\$0.27
	C515ML-050	EA1	\$0.24

PRICE LIST

EFFECTIVE: 9-1-2016

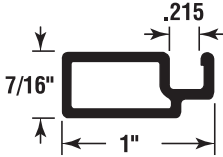
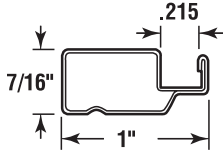

1" ALUMINUM SCREEN FRAME & CORNERS

Product line A1000 / A1099 / D1110 / D1199

SER-114	Part No.	Unit of Measurement	List Price	
1" Extruded screen frame 	114ML122-BX	LF1	\$1.99	
	114SA122-BX	LF1	\$1.99	
	114BZ122-BX	LF1	\$1.99	
	114BA122-BX	LF1	\$1.99	
	114WH122-BX	LF1	\$1.99	
	114AL122-BX	LF1	\$1.99	
	114ML122-PK	LF1	\$2.05	
	114SA122-PK	LF1	\$2.19	
	114BZ122-PK	LF1	\$2.19	
	114BA122-PK	LF1	\$2.19	
	114WH122-PK	LF1	\$2.19	
	114AL122-PK	LF1	\$2.19	
	SER-112			
	1" Screen frame  SER-112 = .032 SER-513 = .025	112ML122-BX	LF1	\$1.24
112GR122-BX		LF1	\$1.24	
112BZ122-BX		LF1	\$1.24	
112WH122-BX		LF1	\$1.24	
112ML122-PK		LF1	\$1.24	
112GR122-PK		LF1	\$1.24	
112BZ122-PK		LF1	\$1.24	
112WH122-PK		LF1	\$1.24	
513ML122-BX		FT	\$0.85	
513GR122-BX		FT	\$0.85	
513BZ122-BX		FT	\$0.85	
513WH122-BX		FT	\$0.85	
513AL122-BX		FT	\$0.85	
513AD122-BX		FT	\$0.85	
513ML122-BN		FT	\$0.87	
513GR122-BN		FT	\$0.87	
513BZ122-BN		FT	\$0.87	
513WH122-BN		FT	\$0.87	
513AL122-BN		FT	\$0.87	
513AD122-BN		FT	\$0.87	
513ML122-PK		FT	\$0.89	
513GR122-PK		FT	\$0.89	
513BZ122-PK		FT	\$0.89	
513WH122-PK		FT	\$0.89	
513AL122-PK		FT	\$0.89	
513AD122-PK		FT	\$0.89	
1" x 7/16" Miter cut corner 		C112ML-050	EA1	\$0.32
		C112ML-060	EA1	\$0.37
	C114ML-040	EA1	\$0.35	
	C513ML-060	EA1	\$0.25	

1-1/4" ALUMINUM SCREEN FRAME & CORNERS

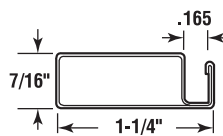
Product line

SER-111	Part No.	Unit of Measurement	List Price
1-1/4" x 7/16" Screen frame 	111BZ122-BX	LF1	Call for price
	111BZ122-PK	LF1	Call for price
1-1/4" x 7/16" Miter cut corner 	C111ML-060	EA1	\$0.56

PRICE LIST

EFFECTIVE: 9-1-2016

LIP & STAND-OFF ALUMINUM SCREEN FRAME

Product line A1000 / D1110

SER-124	Part No.	Unit of Measurement	List Price
	124ML122-BX	LF1	\$1.31
	124GR122-BX	LF1	\$1.36
	124BZ122-BX	LF1	\$1.36
	124WH122-BX	LF1	\$1.36
	124AL122-BX	LF1	\$1.36
	124AD122-BX	LF1	\$1.36
	124ML122-PK	LF1	\$1.22
	124GR122-PK	LF1	\$1.27
	124BZ122-PK	LF1	\$1.27
	124WH122-PK	LF1	\$1.27
	124AL122-PK	LF1	\$1.27
	124AD122-PK	LF1	Call for price
	SER-129		
	129ML122-BX	LF1	\$0.93
	129GR122-BX	LF1	\$1.05
	129BZ122-BX	LF1	\$1.05
	129WH122-BX	LF1	\$1.05
	129ML122-PK	LF1	Call for price
	129GR122-PK	LF1	Call for price
	129BZ122-PK	LF1	\$1.05
	129WH122-PK	LF1	\$1.23
SER-118			
	118ML122-BX	LF1	\$1.10
	118GR122-BX	LF1	\$1.10
	118BZ122-BX	LF1	\$1.10
	118WH122-BX	LF1	\$1.10
	118ML122-PK	LF1	\$1.17
	118GR122-PK	LF1	\$1.17
	118BZ122-PK	LF1	\$1.17
	118WH122-PK	LF1	\$1.17
SER-117			
	117ML122-BX	LF1	\$0.83
	117GR122-BX	LF1	\$0.83
	117BZ122-BX	LF1	\$0.83
	117WH122-BX	LF1	\$0.83
	117AL122-BX	LF1	\$0.83
	117AD122-BX	LF1	\$0.83
	117ML122-PK	LF1	\$0.86
	117GR122-PK	LF1	\$0.86
	117BZ122-PK	LF1	\$0.86
	117WH122-PK	LF1	\$0.86
	117AL122-PK	LF1	\$0.86
	117AD122-PK	LF1	\$0.86
	Corners		
	C117ML-020	EA1	\$0.31
	C115ML-040	EA1	\$0.34
	C115ML-050	EA1	\$0.26

ALUMINUM SCREEN FRAME SPREADER BAR

Product line A1000 / D1310

SER-128	Part No.	Unit of Measurement	List Price
	128ML120-BX	LF1	\$0.43
	128GR120-BX	LF1	\$0.53
	128BZ120-BX	LF1	\$0.53
	128WH120-BX	LF1	\$0.48
	128AL120-BX	LF1	\$0.53
	128AD120-BX	LF1	\$0.53
	128ML120-BN	LF1	\$0.45
	128GR120-BN	LF1	\$0.51
	128BZ120-BN	LF1	\$0.53
	128WH120-BN	LF1	\$0.51
	128AL120-BN	LF1	\$0.51
	128AD120-BN	LF1	\$0.51
	128ML120-PK	LF1	\$0.48
	128GR120-PK	LF1	\$0.59
	128BZ120-PK	LF1	\$0.59
	128WH120-PK	LF1	\$0.59
	128AL120-PK	LF1	\$0.59
128AD120-PK	LF1	\$0.59	
SER-127			
	127ML120-BX	LF1	\$0.69
	127GR120-BX	LF1	\$0.77
	127BZ120-BX	LF1	\$0.77
	127WH120-BX	LF1	\$0.77
	127AL120-BX	LF1	\$0.77
	127AD120-BX	LF1	\$0.77
	127ML120-PK	LF1	\$0.84
	127GR120-PK	LF1	\$0.90
	127BZ120-PK	LF1	\$0.90
	127WH120-PK	LF1	\$0.90
	127AL120-PK	LF1	\$0.90
	127AD120-PK	LF1	\$0.90
	7/8" Spreader bar clip		
	159ML	EA1	\$0.12
5/8" Spreader bar clip			
	160ML	EA1	\$0.07

PRICE LIST

EFFECTIVE: 9-1-2016

ALUMINUM SCREEN FRAME ACCESSORIES

Product line A1050

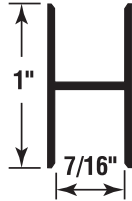
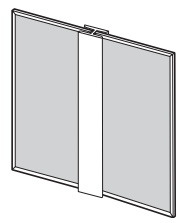
SER-130	Part No.	Unit of Measurement	List Price
7/16" "H" Section frame  	130ML122-BX		\$17.00
	130SA122-BX		\$20.90
	130BZ122-BX		\$20.90
	130WH122-BX		\$20.90
	130AL122-BX		\$20.90
	130AD122-BX		\$20.90
	130ML122-PK		\$22.00
	130SA122-PK		\$26.00
	130BZ122-PK		\$26.00
	130WH122-PK		\$26.00
	130AL122-PK		\$26.00
	130AD122-PK		\$26.00
	130ML122-EA		\$20.00
	130SA122-EA		\$24.80
	130BZ122-EA		\$24.80
	130WH122-EA		\$24.80
	130AL122-EA		\$24.80
	130AD122-EA		\$24.80

SER-185	Part No.	Unit of Measurement	List Price
1" Screen frame circles 	185xx.24	EA1	\$20.12
	185xx.30	EA1	\$22.78
	185xx.36	EA1	\$25.44
	185xx.42	EA1	\$28.22
	185xx.48	EA1	\$30.88
	185xx.60	EA1	\$36.34
	185xx.72	EA1	\$41.66
	185xx.84	EA1	\$46.98
	185xx.96	EA1	\$56.44

Color code chart for Screen frame circles (xx)

AD = Adobe	BZ = Bronze	WH = White
AL = Almond	GR = Gray	

ADJUSTABLE CORNERS

Product line D1110

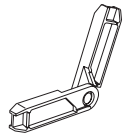
	Part No.	List Price
	AC115BK	\$0.56
	AC1130BK	\$0.61

List Price is per each.

PLASTIC WICKETS

Product line A1150

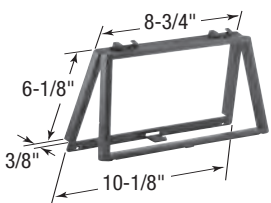
	Part No.	List Price
	190GR	\$6.00
	190BZ	\$6.00
	190WH	\$6.00

List Price is per each.

ALUMINUM WICKETS

Product line A1150

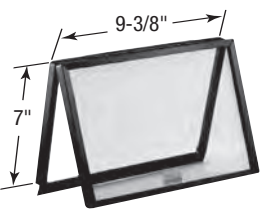
	Part No.	List Price
	188ML	\$29.15
	188BZ	\$34.15
	188WH	\$34.15
	189ML	\$29.15

List Price is per each.

PRICE LIST

EFFECTIVE: 9-1-2016

DIECAST SCREEN CLIPS

Product line A1211

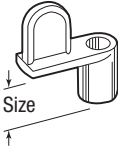
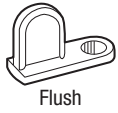

Adobe	Almond	Black	Bronze	List Price	Mill	List Price	White	List Price
1660AD	1660AL	1660BK	1660BZ	\$0.26	1660ML	\$0.15	1660WH	\$0.27
1661AD	1661AL	1661BK	1661BZ	\$0.27	1661ML	\$0.16	1661WH	\$0.28
1662AD	1662AL	1662BK	1662BZ	\$0.28	1662ML	\$0.28	1662WH	\$0.28
1663AD	1663AL	1663BK	1663BZ	\$0.34	1663ML	\$0.20	1663WH	\$0.31
1664AD	1664AL	1664BK	1664BZ	\$0.30	1664ML	\$0.30	1664WH	\$0.30
1665AD	1665AL	1665BK	1665BZ	\$0.31	1665ML	\$0.31	1665WH	\$0.32
1666AD	1666AL	1666BK	1666BZ	\$0.34	1666ML	\$0.25	1666WH	\$0.35
1667AD	1667AL	1667BK	1667BZ	\$0.35	1667ML	\$0.25	1667WH	\$0.37
1668AD	1668AL	1668BK	1668BZ	\$0.56	1668ML	\$0.56	1668WH	\$0.56

List Price is per each.

PLASTIC SCREEN CLIPS

Product line D1310

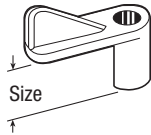
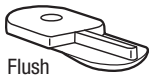

Black	Bronze	Gray	White	List Price
—	—	—	194WH	\$0.08
—	170BZ	170GR	170WH	\$0.08
—	171BZ	171GR	—	\$0.08
—	172BZ	172GR	—	\$0.08
173BK	173BZ	173GR	173WH	\$0.08
—	197BZ	197GR	—	\$0.22

List Price is per each.

CASEMENT CLIPS

Product line D1310

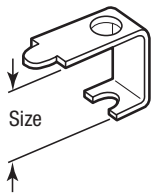

Part No.	List Price
1780ML	\$0.16
179ML	\$0.20
180ML	\$0.23
181ML	\$0.34
182ML	\$0.28

List Price is per each.

RETAINER CLIPS & PULL TABS

Product line D1310



	Mill	Black	White	Gray	List Price
	164ML	—	—	—	\$0.28
	165ML	—	—	—	Call for Price
	152ML	—	152WH	—	\$0.15
	—	153BK	—	153GR	\$0.15
	—	154BK	—	—	\$0.17

List Price is per each.

PRICE LIST

SPRINGS

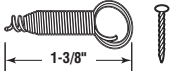
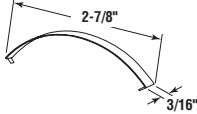
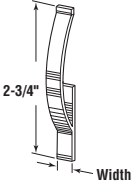
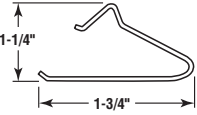
Product line D1310

	Part No.	List Price
	1550SS	\$0.36
	1510ZP	\$0.15
	1490ZP	\$0.15
	1560ZP	\$0.16
	1740CP	\$0.06
	1630CP	\$0.15

List Price is per each.

JIFFY HANGERS & BAIL LATCHES

Product line A1210 / D1310

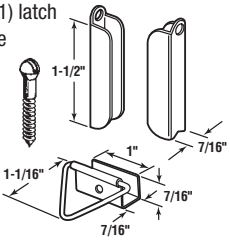
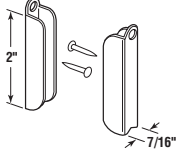
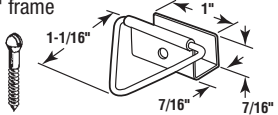
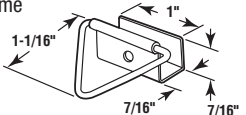
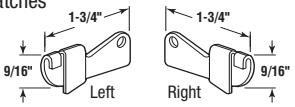
	Part No.	Unit of Measurement	List Price
(2) Hangers & (1) latch For 7/16" frame 	146ML	EA1	\$2.49
	146BZ	EA1	\$2.49
	146WH	EA1	\$2.49
	146GR	EA1	\$2.49
Top hangers For 7/16" frame w/spiral steel nails 	144ML	PR1	\$0.28
	144BZ	PR1	\$0.28
	144WH	PR1	\$0.28
	144GR	PR1	Call for price
Bottom latches For 7/16" frame 	145ML	EA1	\$1.07
	145BZ	EA1	\$1.07
	145WH	EA1	\$1.07
	145GR	EA1	\$1.07
Bottom latches For 7/16" frame No screw 	145BZNS	EA1	Call for price
	145WHNS	EA1	\$0.75
	145GRNS	EA1	Call for price
Knife latches 	175ML	PR1	\$0.68

PRICE LIST

EFFECTIVE: 9-1-2016

PLUNGER LATCHES & SLIDE LOCKS

Product line D1310

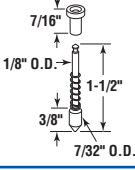
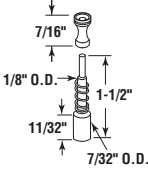
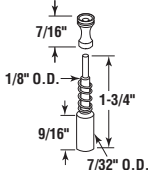
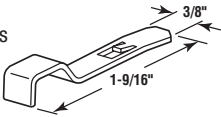
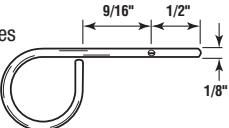
	Part No.	List Price
Plunger latches For 3/4" x 3/8" (or 7/16") frame 	176BK	\$0.37
Plunger latches For 3/4" x 3/8" (or 7/16") frame 	176ML	\$0.37
Plunger latches For 1" x 7/16" Frame 	177ML	\$0.65
Slide lock For all 3/4" frames 	161ML	\$0.22
Lock pins For all 3/4" frames 	1580CP	\$0.20

PRICE LIST

EFFECTIVE: 9-1-2016

WINDOW SCREEN

3/4 in. x 3/8 in. x .020

3/4 in. x 5/16 in. x .020

3/4 in. x 7/16 in. x .020

		Height									
		1'6"	2'0"	2'6"	3'0"	3'6"	4'0"	4'6"	5'0"	5'6"	6'0"
Width	1'6"	\$33.00	\$34.00	\$36.00	\$37.00	\$39.00	\$40.00	\$42.00	\$43.00	\$45.00	\$46.00
	2'0"	\$34.00	\$36.00	\$37.00	\$39.00	\$41.00	\$42.00	\$44.00	\$45.00	\$47.00	\$48.00
	2'6"	\$36.00	\$38.00	\$39.00	\$41.00	\$42.00	\$44.00	\$46.00	\$48.00	\$49.00	\$51.00
	3'0"	\$37.00	\$39.00	\$41.00	\$42.00	\$44.00	\$46.00	\$47.00	\$49.00	\$51.00	\$53.00
	3'6"	\$39.00	\$41.00	\$42.00	\$44.00	\$46.00	\$48.00	\$49.00	\$51.00	\$53.00	\$55.00
	4'0"	\$40.00	\$42.00	\$44.00	\$46.00	\$48.00	\$50.00	\$51.00	\$53.00	\$55.00	\$57.00
	4'6"	\$42.00	\$44.00	\$46.00	\$48.00	\$51.00	\$51.00	\$53.00	\$55.00	\$57.00	\$59.00
	5'0"	\$43.00	\$45.00	—	\$49.00	\$51.00	\$53.00	\$55.00	\$57.00	\$59.00	\$61.00
	5'6"	\$45.00	\$47.00	—	\$51.00	\$53.00	\$55.00	\$57.00	\$59.00	\$64.00	\$66.00
	6'0"	\$46.00	\$48.00	\$51.00	\$53.00	\$55.00	\$57.00	\$59.00	\$61.00	\$66.00	\$69.00

Almond, Bronze, Gray, White

		Height									
		1'6"	2'0"	2'6"	3'0"	3'6"	4'0"	4'6"	5'0"	5'6"	6'0"
Width	1'6"	\$32.00	\$33.00	\$35.00	\$36.00	\$38.00	\$39.00	\$41.00	\$42.00	\$44.00	\$45.00
	2'0"	\$33.00	\$35.00	\$36.00	\$38.00	\$40.00	\$41.00	\$43.00	\$44.00	\$46.00	\$47.00
	2'6"	\$35.00	\$37.00	\$38.00	\$40.00	\$41.00	\$43.00	\$45.00	\$47.00	\$48.00	\$50.00
	3'0"	\$36.00	\$38.00	\$40.00	\$41.00	\$43.00	\$45.00	\$46.00	\$48.00	\$50.00	\$52.00
	3'6"	\$38.00	\$40.00	\$41.00	\$43.00	\$45.00	\$47.00	\$48.00	\$50.00	\$52.00	\$54.00
	4'0"	\$39.00	\$41.00	\$43.00	\$45.00	\$47.00	\$49.00	\$50.00	\$52.00	\$54.00	\$56.00
	4'6"	\$41.00	\$43.00	\$45.00	\$47.00	\$50.00	\$50.00	\$52.00	\$54.00	\$56.00	\$58.00
	5'0"	\$42.00	\$44.00	—	\$48.00	\$50.00	\$52.00	\$54.00	\$56.00	\$58.00	\$60.00
	5'6"	\$44.00	\$46.00	—	\$50.00	\$52.00	\$54.00	\$56.00	\$58.00	\$63.00	\$65.00
	6'0"	\$45.00	\$47.00	\$50.00	\$52.00	\$54.00	\$56.00	\$58.00	\$60.00	\$65.00	\$68.00

Mill

Screen: 18"X 16" Charcoal Fiberglass (or) Gray Fiberglass Screening

Corners: Aluminum Stamped Inside Corners

Spline: Black Serrated Vinyl Spline

Hardware: All above pricing include; vinyl pulltabs (2) and spring clips (2)

PRICE LIST

FIBERGLASS SCREENING (18 X 16)

Product line B2000

Charcoal	List Price	Gray	List Price
CF18	\$38.99	FG18	\$38.99
CF20	\$42.99	FG20	\$46.99
CF22	\$46.99	FG22	\$46.99
CF24	\$50.99	FG24	\$50.99
CF26	\$54.99	FG26	Call for price
CF28	\$58.99	FG28	\$58.99
CF30	\$62.99	FG30	\$62.99
CF32	\$66.99	FG32	Call for price
CF34	\$70.99	FG34	Call for price
CF36	\$74.99	FG36	\$74.99
CF38	\$78.99	FG38	\$78.99
CF40	Call for price	FG40	\$82.99
CF42	\$86.99	FG42	\$86.99
CF44	Call for price	FG44	Call for price
CF46	\$96.99	FG46	Call for price
CF48	\$106.99	FG48	\$106.99
CF54	\$116.99	FG54	Call for price
CF60	\$126.99	FG60	\$126.99
CF72	\$142.99	FG72	\$142.99
CF84	\$147.99	FG84	Call for price

FIBERGLASS SCREENING (18 X 16 ROM)

Product line B2002

Charcoal	List Price	Gray	List Price
CFL18	\$0.27	GFL18	\$0.32
CFL24	\$0.37	GFL24	\$0.42
CFL30	\$0.47	GFL30	\$0.53
CFL32	Call for price	GFL32	Call for price
CFL36	\$0.57	GFL36	\$0.64
CFL42	Call for price	GFL42	Call for price
CFL48	\$0.77	GFL48	\$0.84
CFL60	\$0.93	GFL60	\$1.05
CFL72	\$1.01	GFL72	Call for price

BETTER VUE FIBERGLASS SCREENING

Product line B2000

Charcoal	List Price
BV24	\$68.99
BV30	\$77.99
BV36	\$92.99
BV48	\$125.99
BV60	\$155.99
BV72	\$189.99

BETTER VUE FIBERGLASS SCREENING (ROM)

Product line B2000

Charcoal	List Price
BVL30	Call for price
BVL36	Call for price
BVL48	Call for price
BVL60	Call for price

ULTRA VUE FIBERGLASS SCREENING

Product line B2000

Charcoal	List Price
UV24	\$95.99
UV36	\$154.99
UV48	\$206.99
UV60	\$239.99
UV72	\$285.99

FIBERGLASS SCREENING (18 X 14)

Product line B2001

Charcoal	Gray	List Price
CFH18	FGH18	\$57.99
CFH24	FGH24	\$73.99
CFH30	FGH30	\$91.99
CFH32	FGH32	\$96.99
CFH36	FGH36	\$107.99
CFH42	FGH42	\$127.99
CFH48	FGH48	\$147.99
CFH54	FGH54	\$157.99
CFH60	FGH60	\$167.99
CFH72	FGH72	\$223.99
CFH84	FGH84	\$243.99
CFH96	FGH96	\$319.99
CFH108	FGH108	Call for price

PRICE LIST

EFFECTIVE: 9-1-2016

ALUMINUM SCREENING (18 X 16)

Product line B2003

Silver	List Price	Charcoal	Black	List Price
AL18	\$64.99	CA18	BA18BK	\$66.99
AL20	\$66.99	CA20	BA20BK	\$67.85
AL22	\$70.99	CA22	BA22BK	\$74.35
AL24	\$87.99	CA24	BA24BK	\$85.99
AL26	Call for price	CA26	BA26BK	\$88.15
AL28	\$89.99	CA28	—	Call for price
AL30	\$109.99	CA30	BA30BK	\$129.99
AL32	Call for price	CA32	BA32BK	\$108.45
AL34	Call for price	CA34	BA34BK	\$114.95
AL36	\$147.99	CA36	BA36BK	\$139.99
AL38	Call for price	CA38	—	Call for price
AL40	Call for price	CA40	BA40BK	\$149.99
AL42	Call for price	CA42	BA42BK	\$142.15
AL44	Call for price	—	—	Call for price
AL48	\$174.99	CA48	BA48BK	\$199.99
AL54	Call for price	—	—	Call for price
AL60	\$224.99	CA60	BA60BK	\$269.99
AL72	\$267.55	CA72	BA72BK	\$264.95

STAINLESS STEEL SCREENING (18 X 16)

Product line B2000

Stainless Steel	List Price
SV36	Call for price
SV48	Call for price

PHIFER SUN SCREEN (70% BLOCK)

Product line B2006

Charcoal	List Price	Gray	List Price
SCC24	\$146.99	SCG24	Call for price
SCC30	\$172.99	SCG30	Call for price
SCC36	\$252.99	SCG36	\$209.00
SCC42	\$195.99	SCG42	Call for price
SCC48	\$336.99	SCG48	\$279.00
SCC60	\$419.99	SCG60	Call for price
SCC72	\$519.99	SCG72	Call for price
SCC84	\$537.99	SCG84	Call for price

FIBERGLASS SCREENING (20 X 20)

Product line B2006

Charcoal	List Price
TTB36	\$195.99
TTB48	\$259.99
TTB60	\$269.99

SOLAR INSECT (65% BLOCK)

Product line B2006

Charcoal	List Price	Gray	List Price
TWB24	\$129.72	TWG24	Call for price
TWB30	\$162.15	TWG30	Call for price
TWB36	\$187.99	TWG36	\$249.99
TWB48	\$336.99	TWG48	\$336.99
TWB60	\$432.99	TWG60	Call for price
TWB72	\$462.75	TWG72	Call for price
TWB84	\$481.25	TWG84	Call for price

SUPER SOLAR (90% BLOCK)

Product line B2006

Charcoal	List Price	Gray	List Price
SSC36	\$252.99	SSG36	\$209.00
SSC48	\$336.99	SSG48	\$279.00
SSC60	\$419.99	SSG60	Call for price
SSC84	\$519.99	SSG84	Call for price

PRICE LIST

EFFECTIVE: 9-1-2016

SUN TEX 80 (80% BLOCK)

Product line B2005

Bronze	Black	Brown	Stucco	Gray	List Price
STR36	STBK36	STN36	STS36	STG36	\$304.99
STR48	STBK48	STN48	STS48	STG48	\$406.99
STR60	STBK60	STN60	STS60	STG60	\$507.99
STR72	STBK72	STN72	STS72	STG72	\$649.99
STR96	STBK96	STN96	STS96	STG96	\$809.99

SUN TEX 90 (90% BLOCK)

Product line B2005

Bronze	List Price	Black	List Price	Brown	List Price
SXR36	Call for price	SXBK36	\$389.99	SXN36	\$389.99
SXR48	Call for price	SXBK48	\$519.99	SXN48	Call for price
SXR60	Call for price	SXBK60	\$639.99	SXN60	\$639.99
SXR72	Call for price	SXBK72	\$779.99	SXN72	Call for price
SXR96	Call for price	SXBK96	Call for price	SXN96	Call for price

Stucco	List Price	Gray	List Price
SXS36	\$389.99	SXG36	Call for price
SXS48	Call for price	SXG48	\$429.99
SXS60	\$639.99	SXG60	Call for price
SXS72	\$682.99	SXG72	Call for price
SXS96	\$853.00	SXG96	Call for price

PET SCREEN

Product line B2006

Charcoal	List Price	Gray	List Price
PSBK36	\$279.00	PSG36	\$292.00
PSBK48	\$372.00	PSG48	\$389.00
PSBK60	\$462.00	PSG60	\$459.00

TUFF SCREEN

Product line B2006

Black	List Price
TPSBK36	\$232.00
TPSBK48	\$310.00
TPSBK60	\$389.00
TPSBK96	\$621.00

ALUMINUM GRILLE CLOTH

Product line B2008

Black	List Price
GC36	\$285.99
GC48	\$339.99

GLASSINE

Product line B2008

.012 Ga.	Price List
GL36	\$6.03
GL48	\$8.02
GL54	\$9.20

.015 Ga.	Price List
GH36	\$7.28
GH48	\$9.82
GH54	\$10.85

PRICE LIST

EFFECTIVE: 9-1-2016

SERRATED SPLINE (BULK 15 LBS.)

Product line A1410

Black	Gray	List Price
187BK.100	N/A	\$63.99
187BK.120	187GR.120	\$63.99
187BK.125	187GR.125	\$63.99
187BK.130	N/A	\$63.99
187BK.135	187GR.135	\$63.99
187BK.140	N/A	\$63.99
187BK.145	N/A	\$63.99
187BK.150	187GR.150	\$63.99
187BK.155	N/A	\$63.99
187BK.160	187GR.160	\$63.99
187BK.165	187GR.165	\$63.99
187BK.170	187GR.170	\$63.99
187BK.175	187GR.175	\$63.99
187BK.180	187GR.180	\$63.99
187BK.185	187GR.185	\$63.99
187BK.190	187GR.190	\$63.99
187BK.195	187GR.195	\$63.99
187BK.200	187GR.200	\$63.99
187BK.205	N/A	\$63.99
187BK.210	187GR.210	\$63.99
187BK.215	187GR.215	\$63.99
187BK.220	187GR.220	\$63.99
187BK.225	187GR.225	\$63.99
187BK.230	187GR.230	\$63.99
187BK.235	187GR.235	\$63.99
187BK.240	187GR.240	\$63.99
187BK.245	187GR.245	\$63.99
187BK.250	187GR.250	\$63.99
187BK.255	N/A	\$63.99
187BK.260	187GR.260	\$63.99

SMOOTH SPLINE

Product line A1410

Black	List Price
187BKA.180	Call for price
187BKA.230	Call for price
187BKA.235	Call for price

PRICE LIST

SCREEN ROLLING TOOLS

Product line K2500

	Part No.	List Price
	PNSR-6000	\$17.00
	PNSR-6100	\$17.00
	PNSR-6200	\$17.00
	PNSR-6300	\$17.00
	PCR-7-20	\$24.40
	PCR-6-22	\$24.40
	PCR-7-22	\$24.40
	PCR-8-22	\$24.40
	PFR-4000 Flat roller	\$34.00

SCREWS

Product line K2604 / 2606

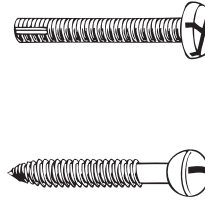

Screen Clip Screw	List Price
1052	\$0.13
1053	\$0.15
1054	\$0.23
1055	\$0.23
Ball Head Screw	List Price
1068	Call for price

List Price is per each.

BLIND RIVET

Product line K2608



Adobe	List Price	Almond	List Price	Black	List Price	Bronze	List Price	Mill	List Price	White	List Price
1082AD	Call for price	1082AL	Call for price	1082BK	Call for price	1082BZ	Call for price	1082ML	Call for price	1082WH	Call for price
1083AD	Call for price	1083AL	Call for price	1083BK	Call for price	1083BZ	Call for price	1083ML	Call for price	1083WH	Call for price
1084AD	Call for price	1084AL	Call for price	1084BK	\$0.19	1084BZ	\$0.19	1084ML	\$0.07	1084WH	\$0.19
1085AD	Call for price	1085AL	Call for price	1085BK	Call for price	1085BZ	Call for price	1085ML	\$0.07	1085WH	Call for price
1086AD	Call for price	1086AL	Call for price	1086BK	Call for price	1086BZ	Call for price	1086ML	Call for price	1086WH	Call for price
1087AD	Call for price	1087AL	Call for price	1087BK	Call for price	1087BZ	Call for price	1087ML	Call for price	1087WH	Call for price

List Price is per each.

GLAZING VINYL

Product line K1510

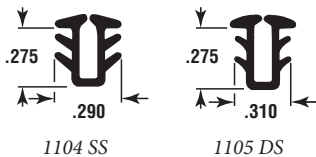

Part No.	List Price
1104BK	\$0.20 / ft.
1105BK	\$0.20 / ft.

GRID BAR

Product line A1010

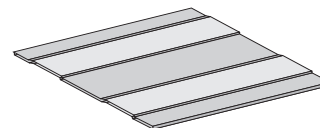

Part No.	List Price
1118BZ	\$0.35
1118WH	\$0.35

MUNTIN BAR

Product line A1010

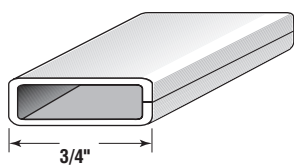

Part No.	List Price
1111WH	\$0.65 / ft.

GLAZING BEAD

Product line A1010

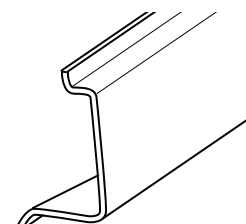







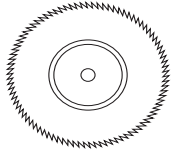
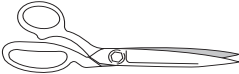

Part No.	List Price
1127BZ	Call for price
1127GR	\$0.39
1127ML	Call for price
1127WH	Call for price

PRICE LIST

EFFECTIVE: 9-1-2016

TOOLS & SUPPLIES

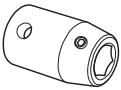
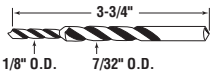
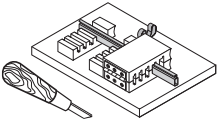
Product line F3807 / G 8100 / G 8705 / K2500 / K2550

	Part No.	List Price
	9593	\$183.00
	9594	\$203.00
	9596	\$198.00
	9029	Call for price
	9030	Call for price
	9653	Call for price
	1007	\$37.15
	1014	\$10.30
	2858	Call for price
	8900	\$21.00
	8901	\$11.70
	9017	\$8.00
	9024	\$100.00
	8720	\$25.00
	8721	
	8722	
	8723	
	8727	
	8757	

CUT-OFF GAUGE REPLACEMENT TAPE

Product line K2550

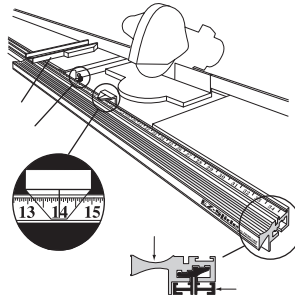

Part No.	List Price
9704	\$24.00
9705	\$25.00

PRICE LIST

EFFECTIVE: 9-1-2016

ACCU-RULE MEASURING STICK

PATENT PENDING

- Quickly and accurately measures vertical sliding screen door dimensions in the patio door opening.
- Two (2) piece (extruded aluminum) adjustable measuring tool.
- Locking knob holds firm while overall measurement is read.
- Multiple vertical dimensions are needed to determine ideal screen door height.

	Minimum Dimension	Extended Dimension	List Price
P 8067	12"	20"	\$55.49
P 8066	20"	38"	\$115.49
P 8065	32"	62"	\$165.49
P 8064	62"	122"	\$175.49
P 8120 (Set of 4)	—	—	\$479.89
P 8381 (Set of 3) P-8064, P-8065 & P-8066	—	—	\$409.29

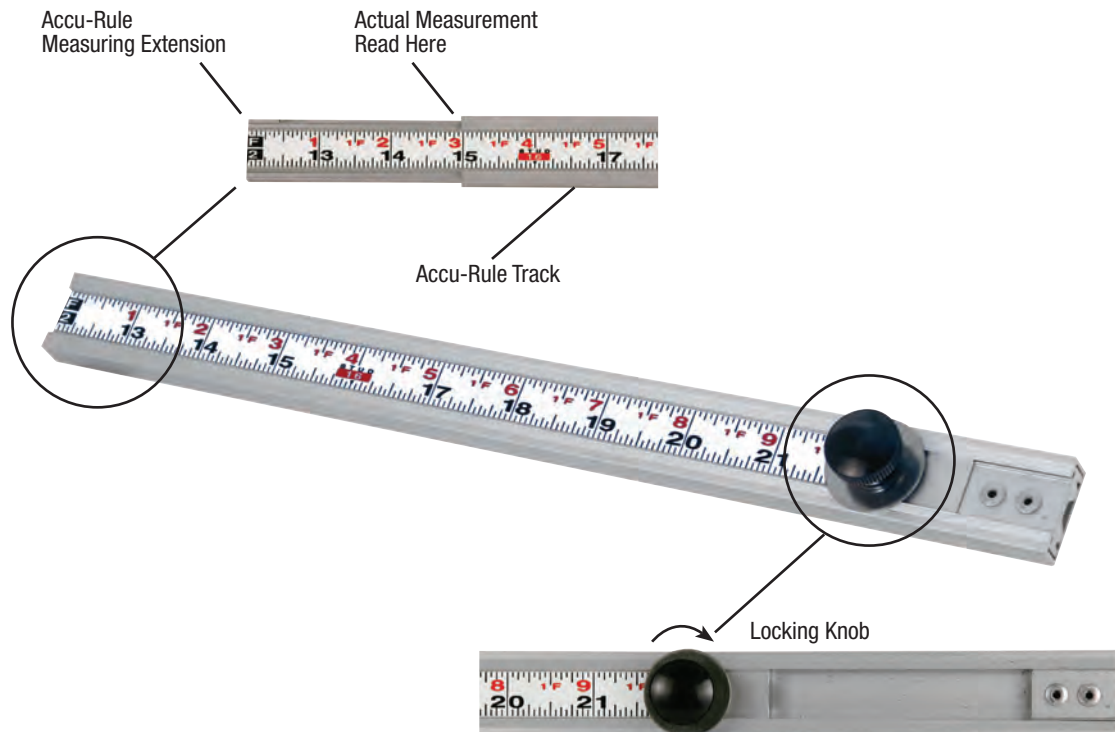
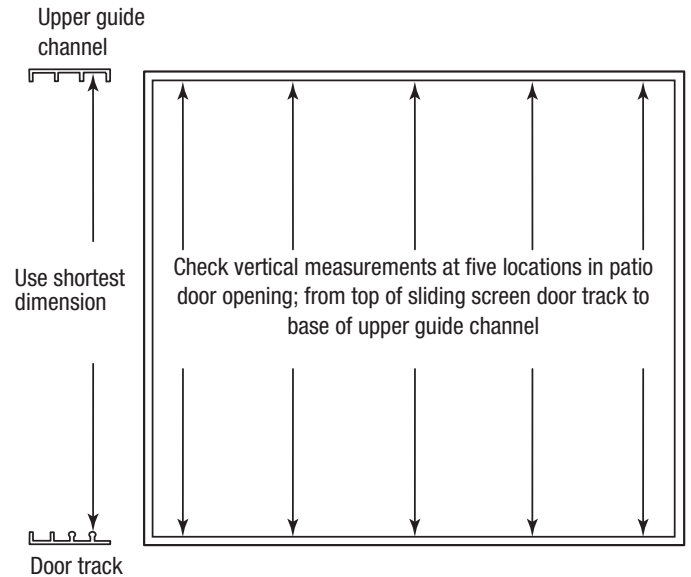

ASK ABOUT CUSTOM WATER JET CUT PATTERNS

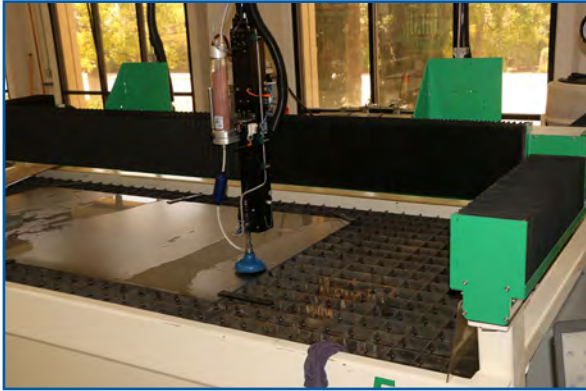

Precision can help design* and manufacture custom panels for security doors, fencing & gates.

DESIGN INSPIRATION

